

ANGULAR GRIPPERS WITH OPENING ANGLE OF 30°

SERIES CGAN

DOUBLE ACTING, MAGNETIC, SELF CENTERING
SIZES: 10, 16, 20, 25, 32



- Compact and light design
- Flexible mounting
- Fixing on 3 sides
- High closing and opening speed
- Position detection thanks to the use of Series CSD magnetic proximity switches

Series CGAN angular grippers are available in 5 different sizes. Thanks to an opening angle of between -10° and 30° , the Series CGAN angular grippers guarantee a fast and efficient grip even in reduced workspaces. Its compact design and the materials used, make this gripper particularly suitable for all those applications requiring high precision and position repeatability such as Transferring, Pick & Place or Pick & Hold.

Fixing points on three different sides of the gripper body and its easy mounting by means of an optional adaptor, guarantee highly flexible installation, even in industrial sectors that demand high levels of production efficiency such as the assembly, packaging and Food & Beverage sectors.

GENERAL DATA

Type of construction	Self centering angular gripper
Operation	Double-acting
Sizes	10; 16; 20; 25; 32
Force transmission	Lever system
Opening torque at 6 bar	14 - 280 (Ncm)
Closing torque at 6 bar	10 - 230 (Ncm)
Opening/closing angle	2x15°
Air connections	M3 - M5
Operating pressure	2 ÷ 8 bar
Operating temperature	5°C ÷ 60°C
Store temperature	-10°C ÷ 80°C
Maximum use frequency	3 Hz
Repeatability	0.05°
Medium	Filtered air in class 7.4.4 according to ISO 8573-1. In case lubricated air is used, we recommend ISOVG32 oil and to never interrupt lubrication.
Compatibility	ROHS Directive
Certifications	ATEX (II 2GD c IIC 120°C(T4)-20°C≤Tas80)
Materials	PTFE, Silicone and Copper free
Compatible magnetic proximity switches	Series CSD

ANGULAR GRIPPERS WITH OPENING ANGLE OF 30°
SERIES CGAN - CODING EXAMPLE

CODING EXAMPLE

CGAN	-	20	-	EX
CGAN	SERIES			PNEUMATIC SYMBOL
20	SIZES: 10 16 20 25 32			PNZ1
EX	Add EX to order the certified ATEX version			

GRIPPERS

3

Pneumatic symbols

The pneumatic symbol indicated in the CODING EXAMPLE is shown below.

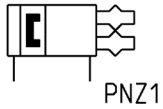

Series CGAN grippers - construction

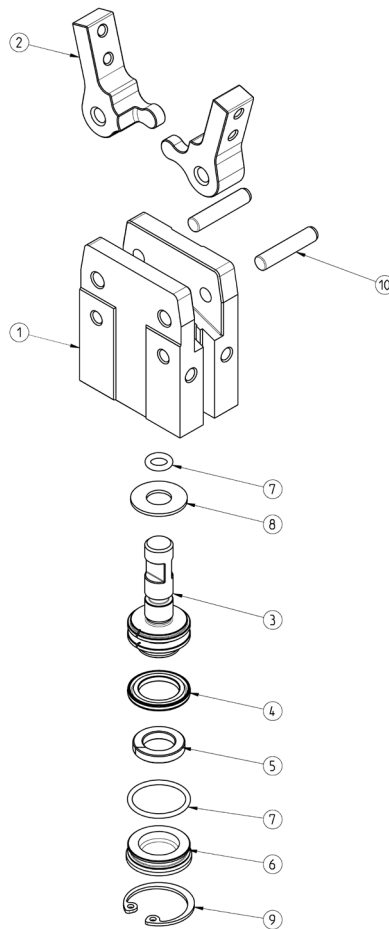

PARTS	Materials
1 - Body	Aluminium alloy
2 - Jaw	Stainless steel
3 - Piston	Stainless steel
4 - Seal	NBR
5 - Magnet	Plastoferrite
6 - Rear end cap	Acetal POM
7 - O-ring	NBR - HNBR
8 - Cushioning	PU Polyurethane
9 - Seeger	Stainless steel
10 - Pin	Steel

**ANGULAR GRIPPERS WITH OPENING ANGLE OF 30°
 SERIES CGAN - DIMENSIONAL CHARACTERISTICS**
Gripper - size 10 mm

GRIPPERS

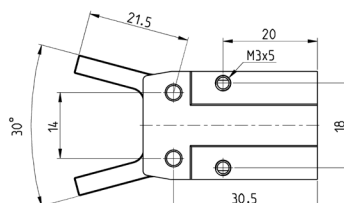
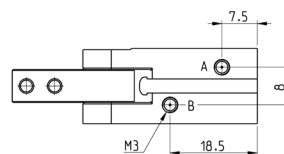
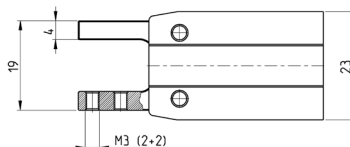
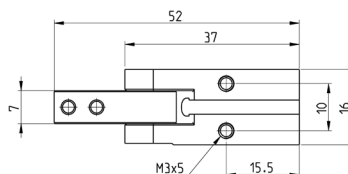
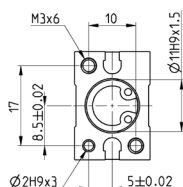
3

DRAWING LEGEND:
A = Opening of air connection
B = Closing of air connection

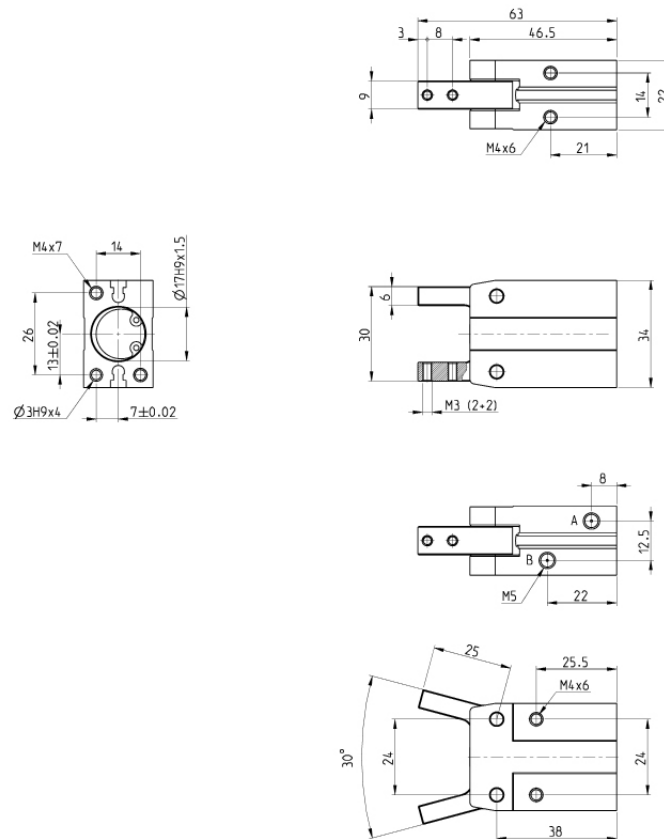
Mod.	Total closing gripping force at 6 bar (N)	Closing gripping force per jaw at 6 bar (N)	Total opening gripping force at 6 bar (N)	Opening gripping force per jaw at 6 bar (N)	Stroke per jaw (°)	Working pressure (bar)	Working temperature (°C)	Repeatability (°)	Max use frequency (Hz)	Weight (kg)
CGAN-10	10,5	5,25	14	7	15°	2 ÷ 8	5 ÷ 60	0,05	3	0,045

**ANGULAR GRIPPERS WITH OPENING ANGLE OF 30°
SERIES CGAN - DIMENSIONAL CHARACTERISTICS**
Gripper - size 16 mm

DRAWING LEGEND:
A = Opening of air connection
B = Closing of air connection

Mod.	Total closing gripping force at 6 bar (N)	Closing gripping force per jaw at 6 bar (N)	Total opening gripping force at 6 bar (N)	Opening gripping force per jaw at 6 bar (N)	Stroke per jaw (°)	Working pressure (bar)	Working temperature (°C)	Repeatability (°)	Max use frequency (Hz)	Weight (kg)
CGAN-16	50	25	62	31	15°	2 ÷ 8	5 ÷ 60	0,05	3	0,112

**ANGULAR GRIPPERS WITH OPENING ANGLE OF 30°
 SERIES CGAN - DIMENSIONAL CHARACTERISTICS**
Gripper - size 20 mm

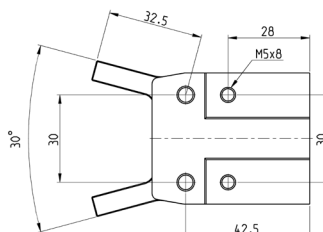
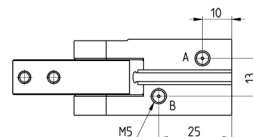
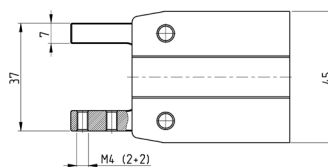
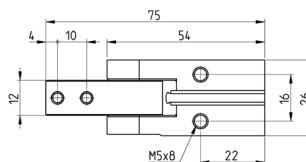
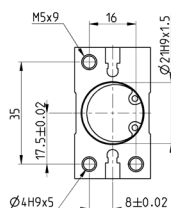
GRIPPERS

3

DRAWING LEGEND:

A = Opening of air connection

B = Closing of air connection

Mod.	Total closing gripping force at 6 bar (N)	Closing gripping force per jaw at 6 bar (N)	Total opening gripping force at 6 bar (N)	Opening gripping force per jaw at 6 bar (N)	Stroke per jaw (°)	Working pressure (bar)	Working temperature (°C)	Repeatability (°)	Max use frequency (Hz)	Weight (kg)
CGAN-20	97	48,5	120	60	15°	2 ÷ 8	5 ÷ 60	0,05	3	0,213

ANGULAR GRIPPERS WITH OPENING ANGLE OF 30°
SERIES CGAN - DIMENSIONAL CHARACTERISTICS

Gripper - size 25 mm

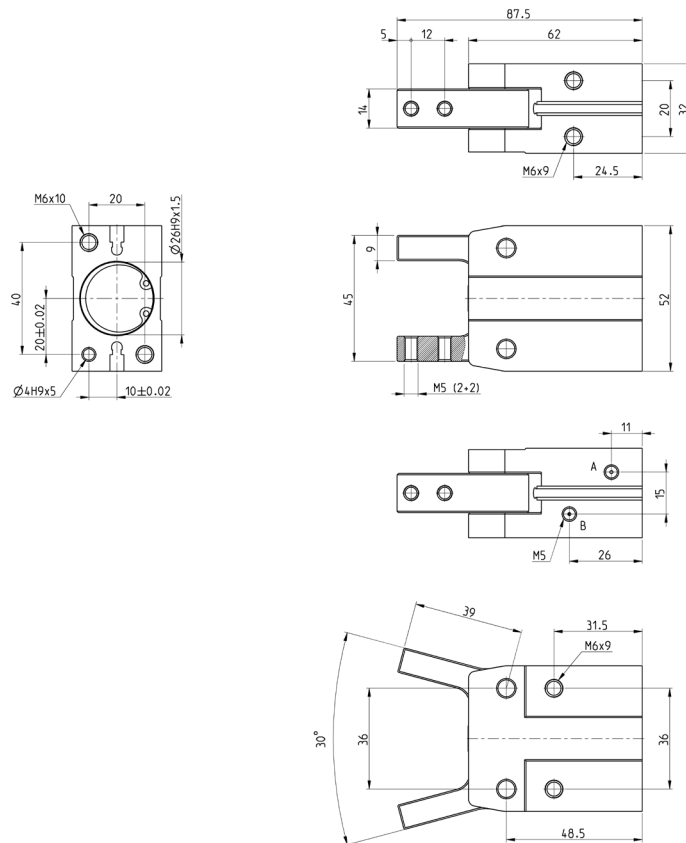

DRAWING LEGEND:
 A = Opening of air connection
 B = Closing of air connection

Mod.	Total closing gripping force at 6 bar (N)	Closing gripping force per jaw at 6 bar (N)	Total opening gripping force at 6 bar (N)	Opening gripping force per jaw at 6 bar (N)	Stroke per jaw (°)	Working pressure (bar)	Working temperature (°C)	Repeatability (°)	Max use frequency (Hz)	Weight (kg)
CGAN-25	185	92,5	232	116	15°	2 ÷ 8	5 ÷ 60	0,05	3	0,355

**ANGULAR GRIPPERS WITH OPENING ANGLE OF 30°
 SERIES CGAN - DIMENSIONAL CHARACTERISTICS**
Gripper - size 32 mm

GRIPPERS

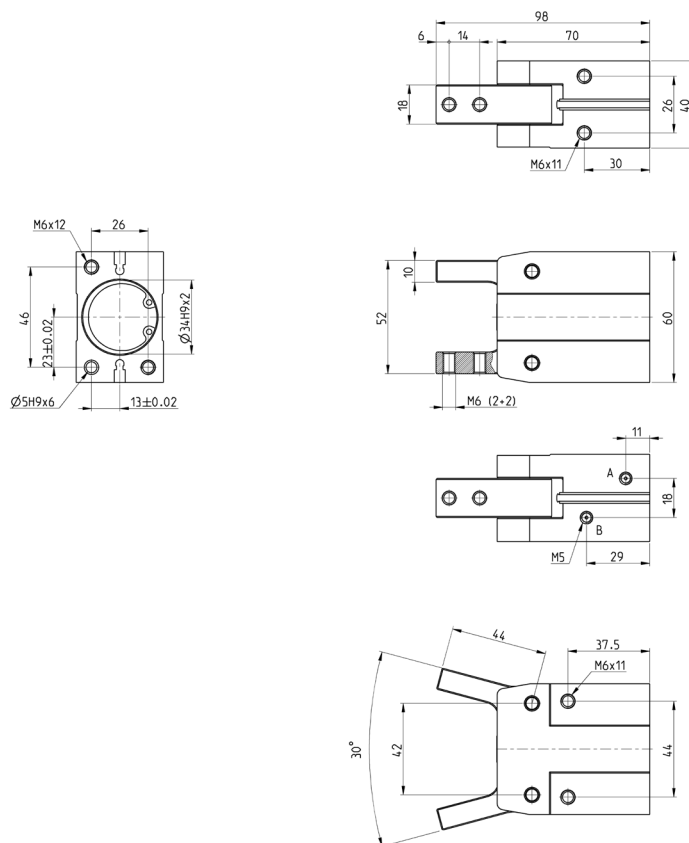
3

DRAWING LEGEND:
A = Opening of air connection
B = Closing of air connection

Mod.	Total closing gripping force at 6 bar (N)	Closing gripping force per jaw at 6 bar (N)	Total opening gripping force at 6 bar (N)	Opening gripping force per jaw at 6 bar (N)	Stroke per jaw (°)	Working pressure (bar)	Working temperature (°C)	Repeatability (°)	Max use frequency (Hz)	Weight (kg)
CGAN-32	235	117,5	292	146	15°	2 ÷ 8	5 ÷ 60	0,05	3	0,585

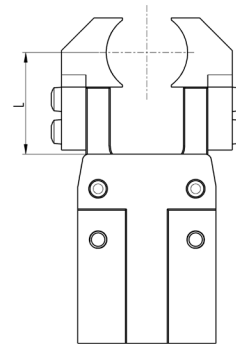
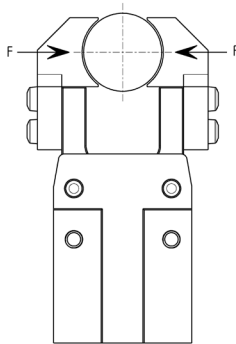
Gripping point



F = Gripping force

L = Arm

Tightening force per single jaw

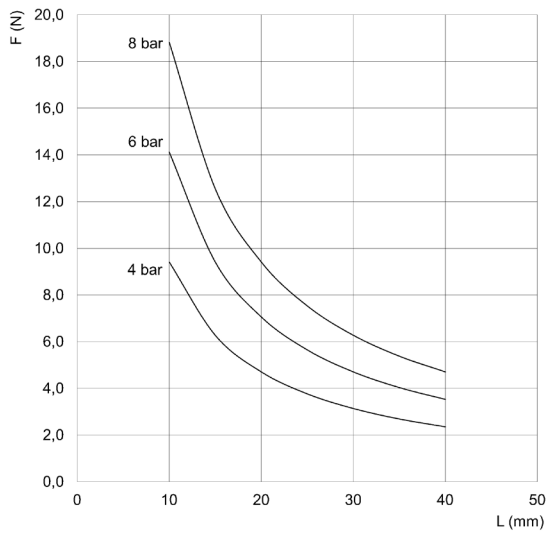

CGAN-10

Opening gripping force
 L = Arm
 F = Gripping force

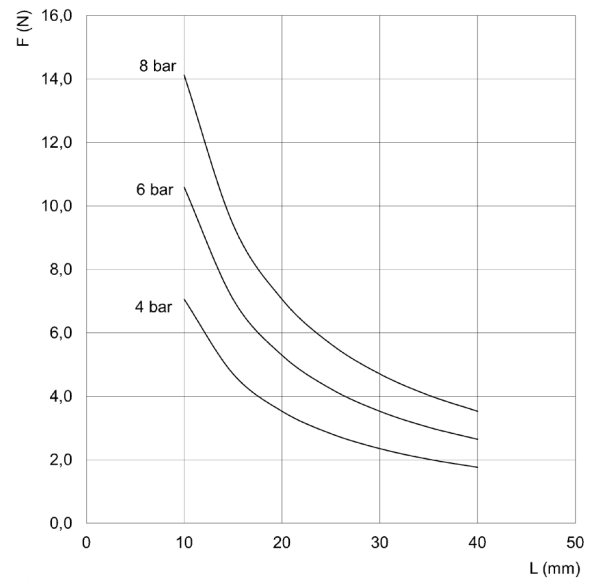

CGAN-10

Closing gripping force
 L = Arm
 F = Gripping force

ANGULAR GRIPPERS WITH OPENING ANGLE OF 30°
SERIES CGAN - DIAGRAMS

GRIPPERS

3

Tightening force per single jaw

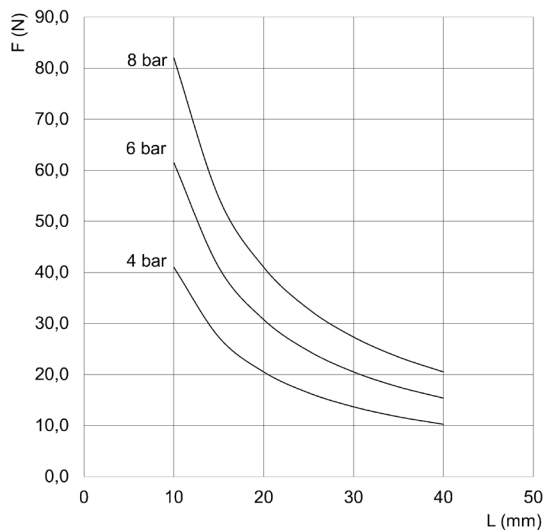

CGAN-16

Opening gripping force
L = Arm
F = Gripping force

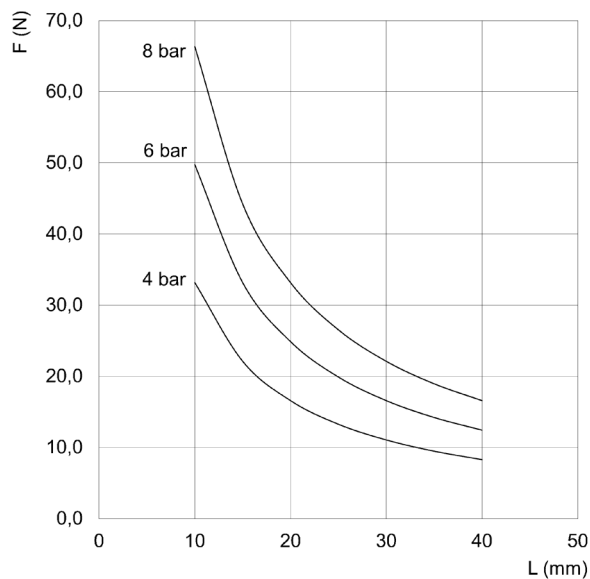

CGAN-16

Closing gripping force
L = Arm
F = Gripping force

Tightening force per single jaw

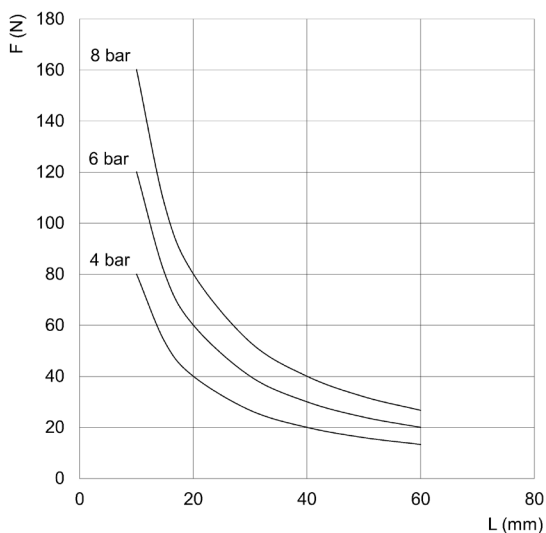

CGAN-20

Opening gripping force
L = Arm
F = Gripping force

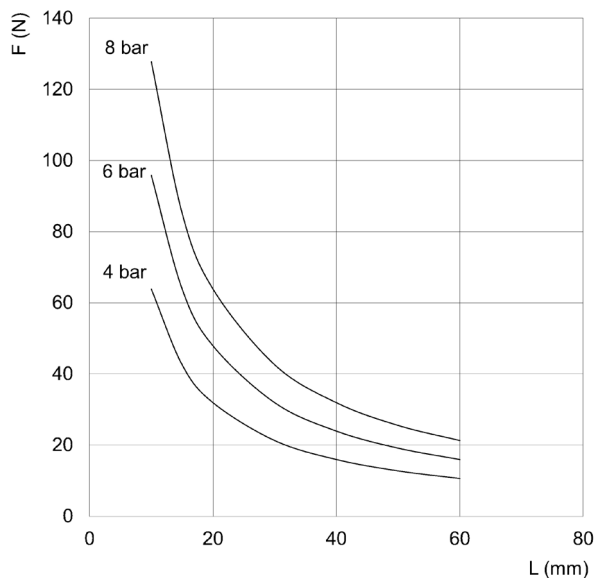

CGAN-20

Closing gripping force
L = Arm
F = Gripping force

Tightening force per single jaw

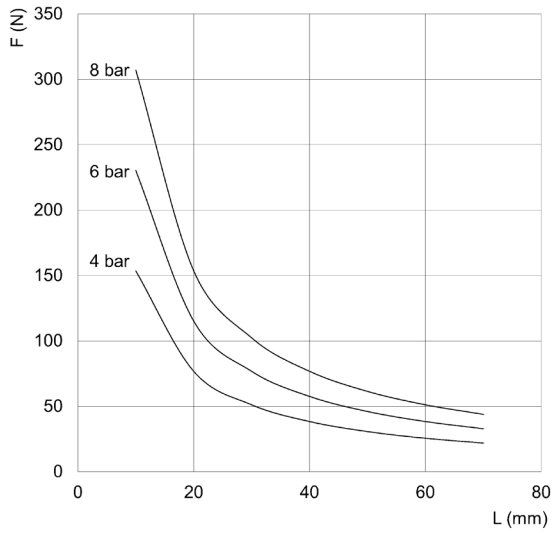

CGAN-25

Opening gripping force
 L = Arm
 F = Gripping force

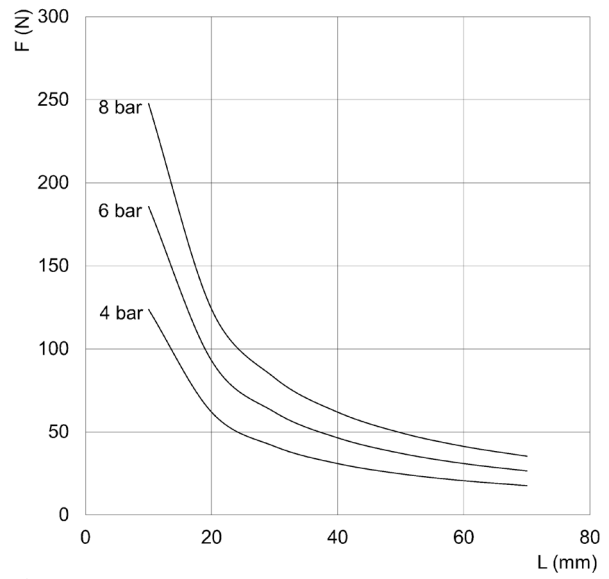

CGAN-25

Closing gripping force
 L = Arm
 F = Gripping force

Tightening force per single jaw

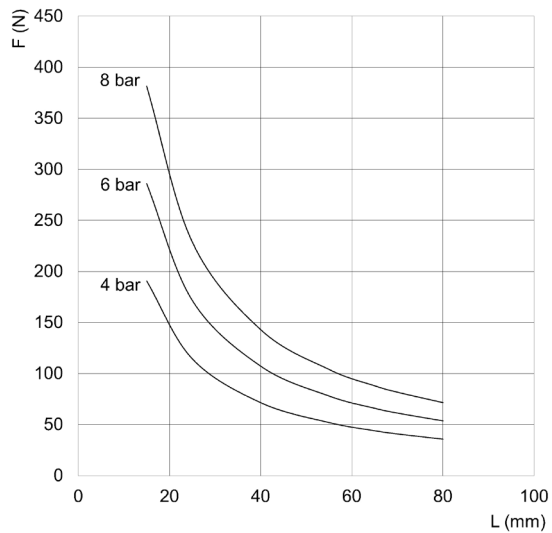

CGAN-32

Opening gripping force
 L = Arm
 F = Gripping force

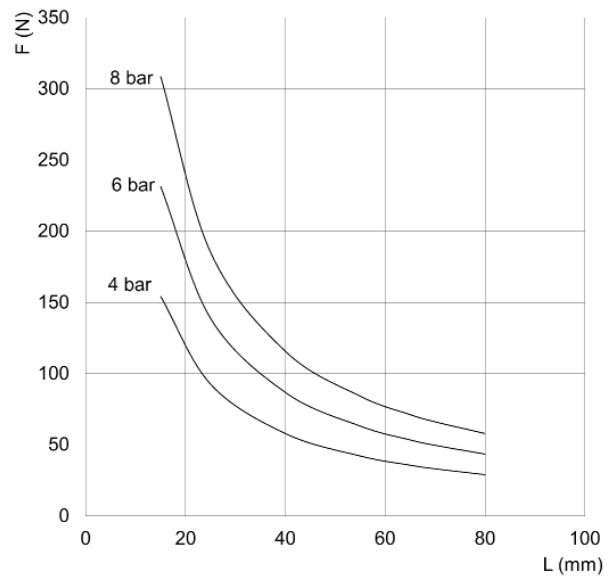

CGAN-32

Closing gripping force
 L = Arm
 F = Gripping force

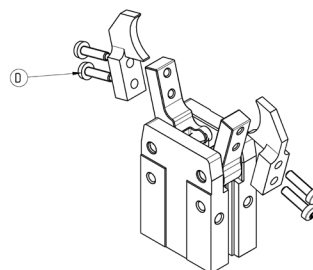
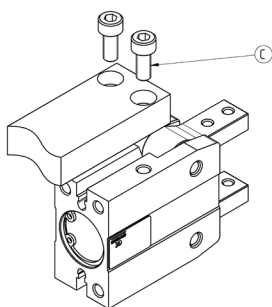
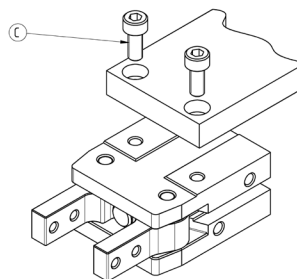
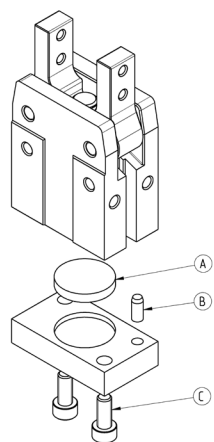
Examples of mounting

Mod.	A	B	C	D
CGAN-10	Ø11	Ø2	M3	M3
CGAN-16	Ø17	Ø3	M4	M3
CGAN-20	Ø21	Ø4	M5	M4
CGAN-25	Ø26	Ø4	M6	M5
CGAN-32	Ø34	Ø5	M6	M6

Air supply ports

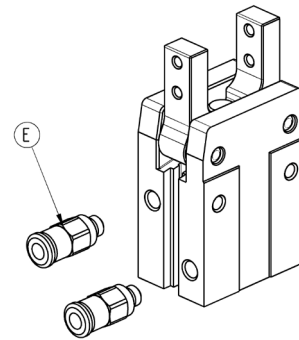

Mod.	E
CGAN-10	M3
CGAN-16	M5
CGAN-20	M5
CGAN-25	M5
CGAN-32	M5

Example of mounting: proximity switches

L = proximity switch mod. CSD-D-334/CSD-H-334 or mod. CSD-D-364/CSD-H-364

In order to position the proximity switch correctly, a channel must be created in the base.

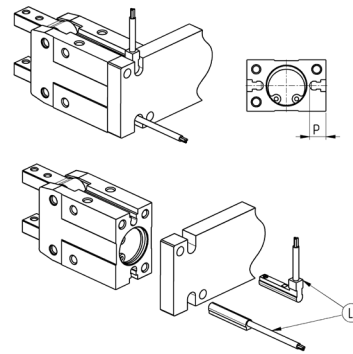

Mod.	P
CGAN-10	5
CGAN-16	7
CGAN-20	10
CGAN-25	10.5
CGAN-32	10.5

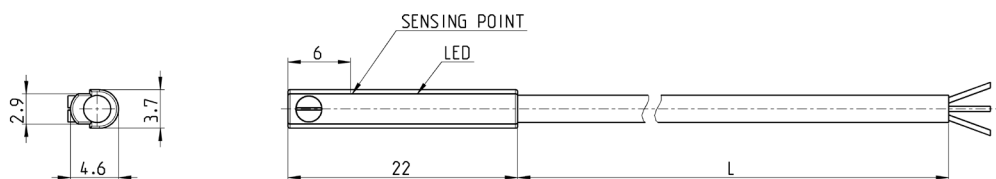
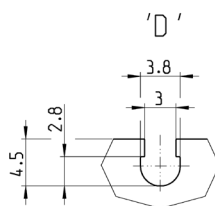
Magnetic proximity switches, 3-wire cable, D-slot

Mod.	Operation	Connections	Voltage	Output	Max. current	Max Load	Protection	L = length cable
CSD-D-334	Magneto-resistive	3 wires	10 + 27 V DC	PNP	200 mA	6W	Against polarity reversing and overvoltage	2 m

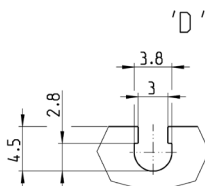
Magnetic proximity switches, male M8 3-pin conn., D-slot, straight

Length of cable 0,3 metres

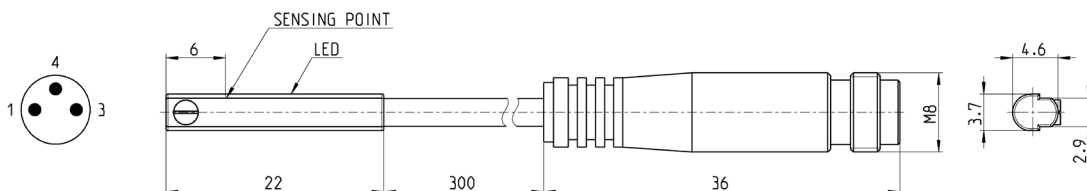

Mod.	Operation	Connection	Voltage	Output	Max. current	Max Load	Protection
CSD-D-364	Magneto-resistive	3 wires with M8 connector	10 + 27 V DC	PNP	200 mA	6 W	Against polarity reversing and overvoltage

Mounting brackets Mod. L-CGP

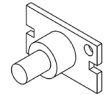
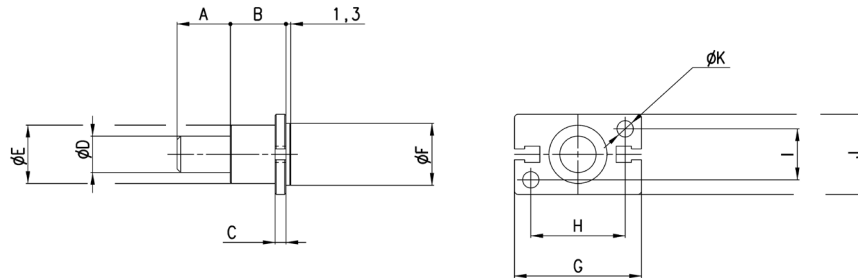
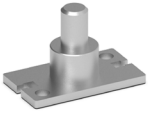

GRIPPERS

3

Mod.	A	B	C	D	E	F	G	H	I	J	K
L-CGP-16	15	15	3	10	16	17	35	26	14	22	4,5
L-CGP-20	15	15	3	10	18	21	46	35	16	26	5,5
L-CGP-25	25	17	5	14	26	26	53	40	20	32	6,6
L-CGP-32	25	20	6	16	30	34	61	46	26	40	6,6

Mounting brackets Mod. C-CGP

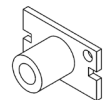
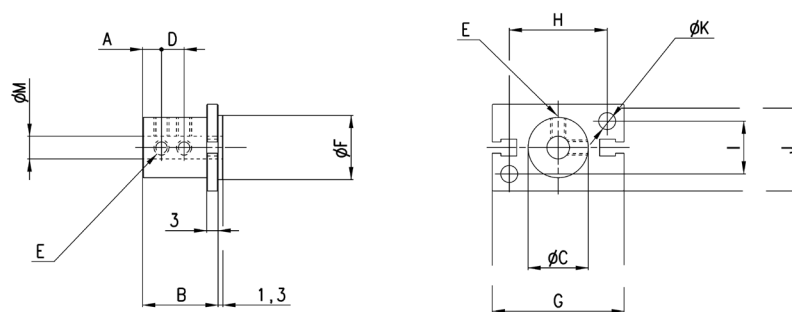

Mod.	A	B	C	D	E	F	G	H	I	J	K	M
C-CGP-16	5	20,5	16	7	M4	17	35	26	14	23	4,5	6
C-CGP-20	7	25,5	20	9	M4	21	46	35	16	27	5,5	8
C-CGP-25	8	30,5	25	10	M4	26	53	40	20	33	6,6	10
C-CGP-32	10	40,5	32	15	M4	34	61	46	26	41	6,6	12