

flat suction pads (oval) - Series VTOF

Product code: VTOF-0300-100S-1/8F

Datasheet creation date: 19/05/2026 18:30

Check the most updated document online [click here](#)



TECHNICAL DATA

Series	VTOF
Materials	S = Silicone
Thread size	G1/8
Thread type	F = female

flat suction pads (oval) - Series VTOF

Product code: VTOF-0300-100S-1/8F

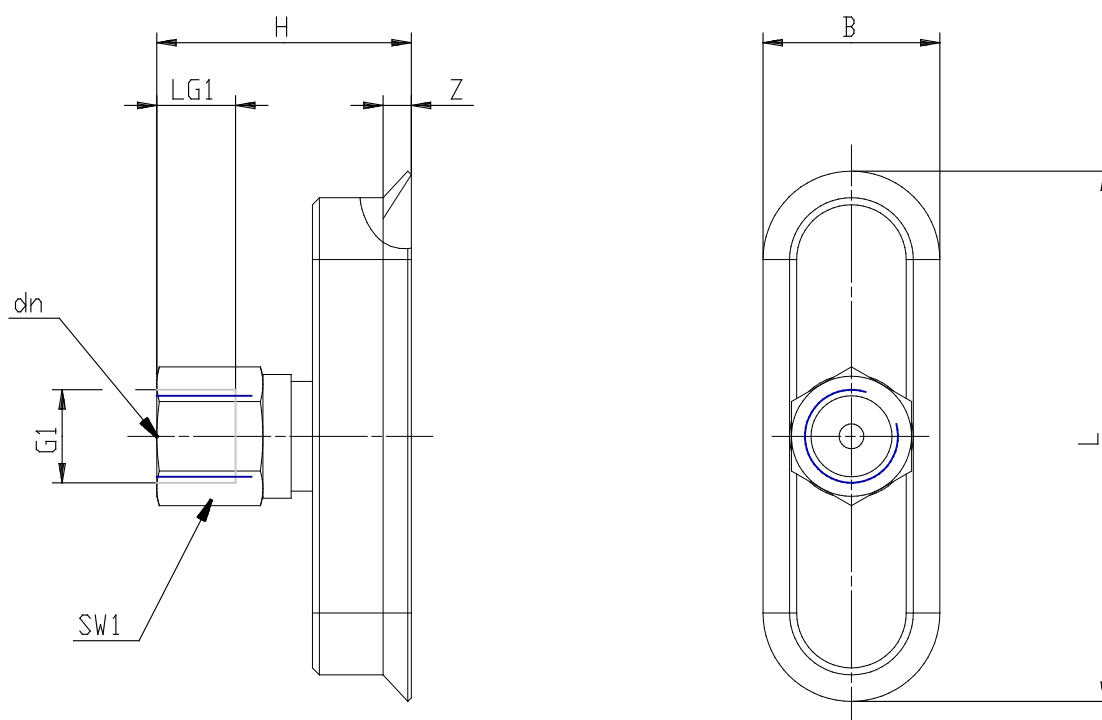

DIMENSIONS

DN (mm)	3.5
G1	G1/8F
H (mm)	25
L (mm)	30
LG1 (mm)	9.0
SW1 (mm)	14
Z (mm)	1.5
Suction pad	VTOF-0300-100*
Nipple	NPV-P-1/8-F