

Quick exhaust valves - Series VSC

Product code: VSC 588-1/8

Datasheet creation date: 19/05/2026 08:50

Check the most updated document online [click here](#)



TECHNICAL DATA

Mod.	VSC 588-1/8
SW (mm)	14
Medium inlet flow rate 1 > 2 at 6 bar, ΔP 1 bar] (NI/min)	630
Medium inlet flow rate 2 > 3 at 6 bar, ΔP 1 bar] (NI/min)	940
Min. operating pressure (bar) (bar)	0,5

Quick exhaust valves - Series VSC

Product code: VSC 588-1/8

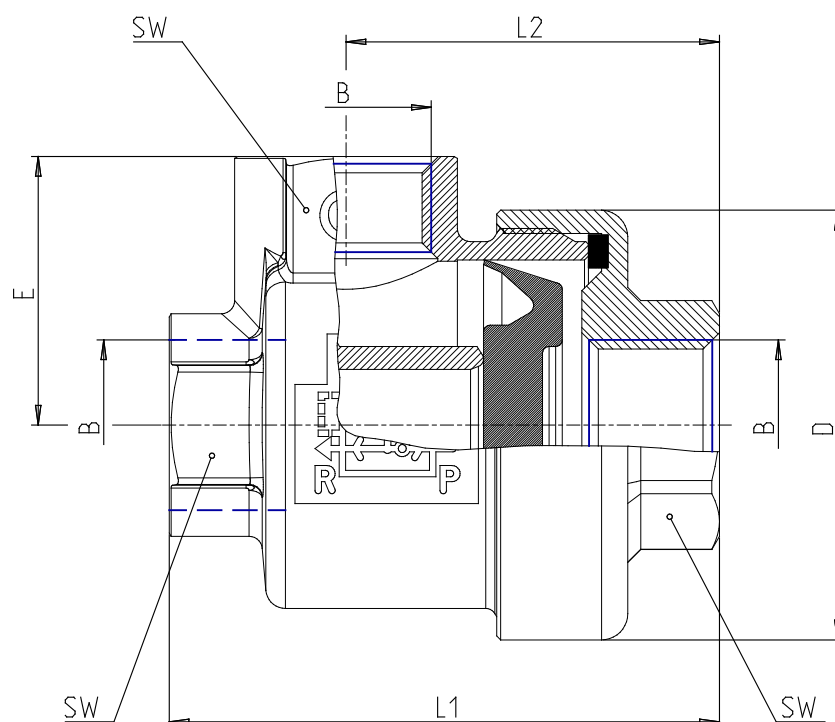

DIMENSIONS

D (mm)	28
E (mm)	17.5
L1 (mm)	36.5
L2 (mm)	25.0