

Solenoids for solenoid valves - Mod. U70/G70

Product code: U73

Datasheet creation date: 19/05/2026 09:00

Check the most updated document online [click here](#)



TECHNICAL DATA

Mod.	U73
Voltage (V)	24
Frequency (Hz)	DC
Power absorption (W)	5

Solenoids for solenoid valves - Mod. U70/G70

Product code: U73

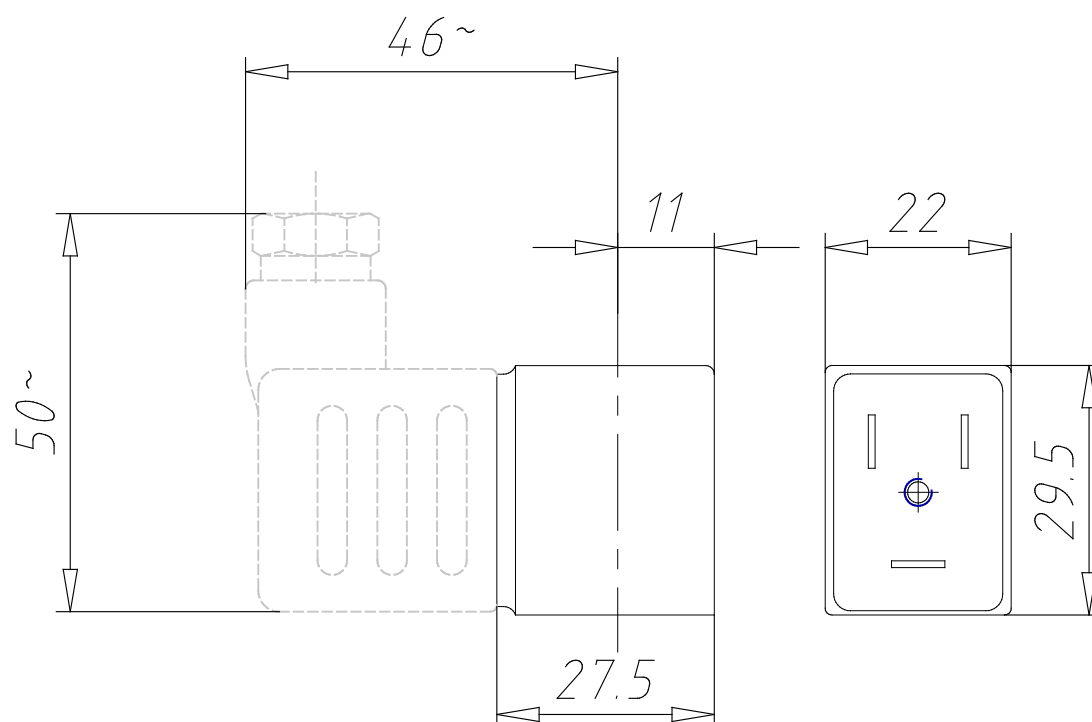

DIMENSIONS

Mod.	U73
Voltage (V)	24
Frequency (Hz)	DC
Power absorption (W)	5