

Valves - Series SCU

Product code: SCU 610-1/2

Datasheet creation date: 19/05/2026 17:11

Check the most updated document online [click here](#)



TECHNICAL DATA

Mod.	SCU 610-1/2
------	-------------

Valves - Series SCU

Product code: SCU 610-1/2

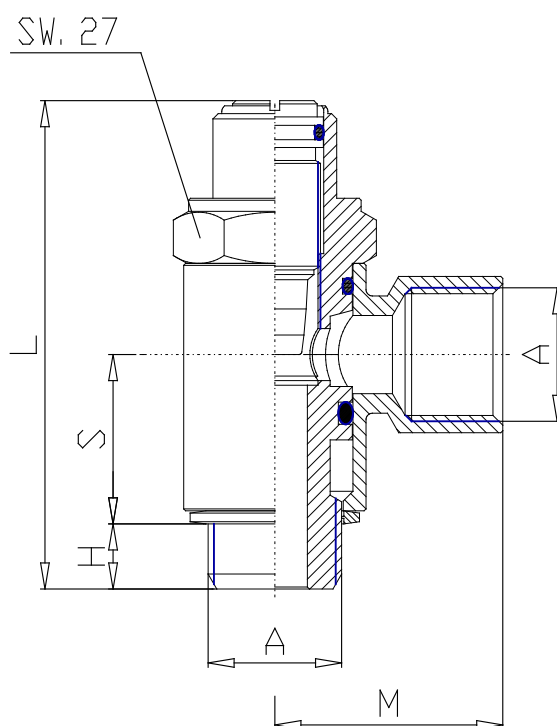

DIMENSIONS

A	G1/2
H (mm)	10.0
L (mm)	75.0
S (mm)	26.0
M (mm)	35
SW (mm)	27