

Mod. S2530 - Sprint fittings Serie S2000

Product code: S2530 3/8-1/8

Datasheet creation date: 19/05/2026 18:05

Check the most updated document online [click here](#)



TECHNICAL DATA

Mod.	S2530 3/8-1/8
------	---------------

Mod. S2530 - Sprint fittings Serie S2000

Product code: S2530 3/8-1/8

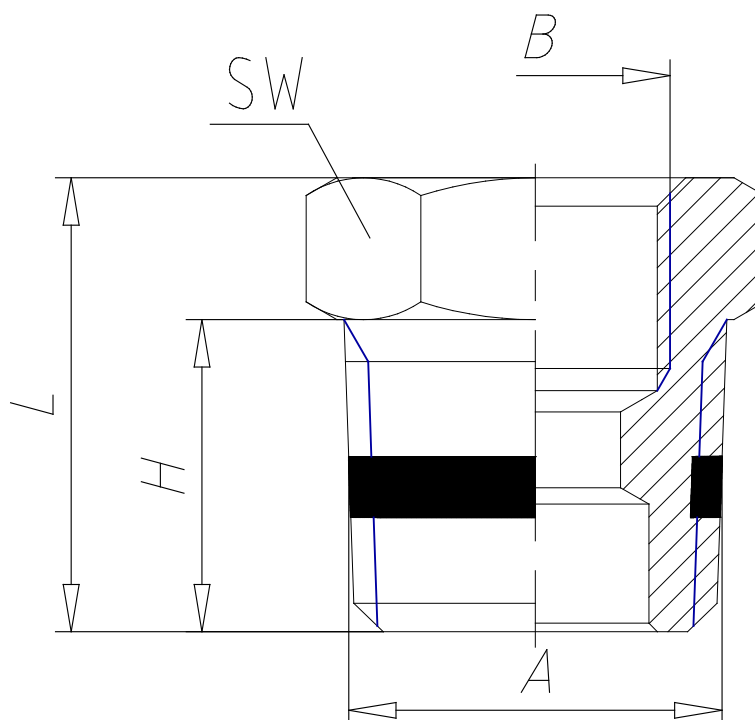

DIMENSIONS

A	R3/8
B	G1/8
H (mm)	11.5
L (mm)	16.5
SW (mm)	17