

Mod. S2530 - Sprint fittings Serie S2000

Product code: S2530 3/8-1/4

Datasheet creation date: 19/05/2026 08:54

Check the most updated document online [click here](#)



TECHNICAL DATA

Mod.	S2530 3/8-1/4
------	---------------

Mod. S2530 - Sprint fittings Serie S2000

Product code: S2530 3/8-1/4

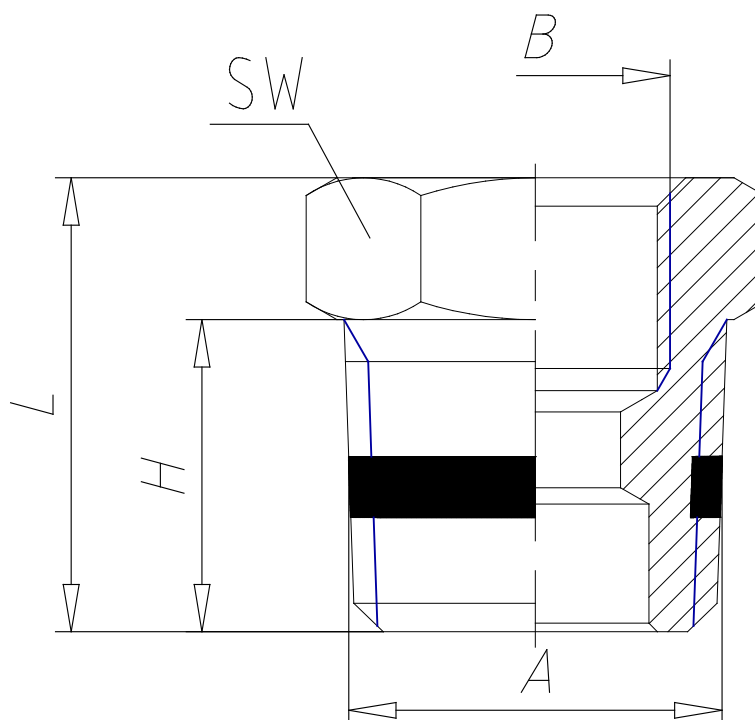

DIMENSIONS

A	R3/8
B	G1/4
H (mm)	11.5
L (mm)	16.5
SW (mm)	17