

Mod. S2530 - Sprint fittings Serie S2000

Product code: S2530 1/2-3/8

Datasheet creation date: 19/05/2026 18:05

Check the most updated document online [click here](#)



TECHNICAL DATA

Mod.	S2530 1/2-3/8
------	---------------

Mod. S2530 - Sprint fittings Serie S2000

Product code: S2530 1/2-3/8

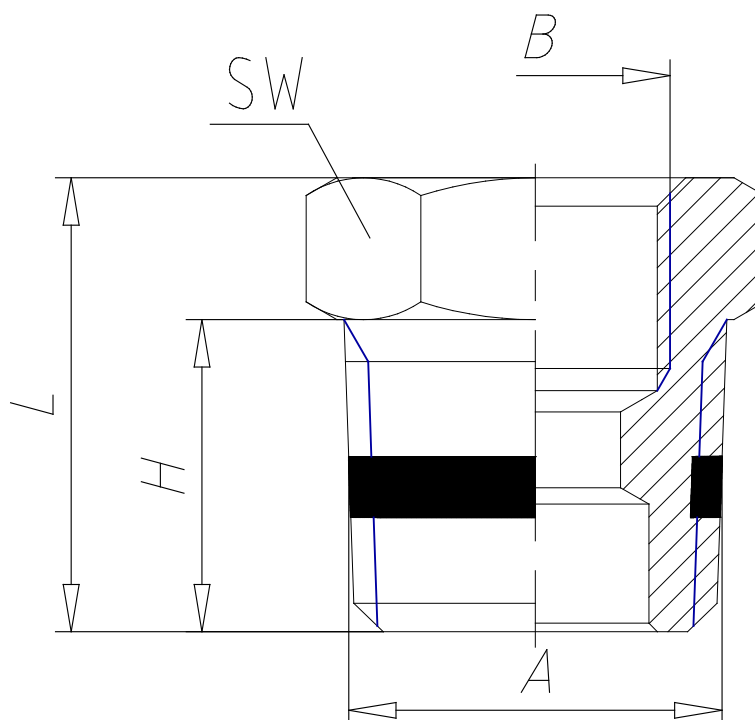

DIMENSIONS

A	R1/2
B	G3/8
H (mm)	14.0
L (mm)	19.5
SW (mm)	22