

## Mod. S2510 - Sprint fittings Serie S2000

Product code: S2510 3/8-1/2

Datasheet creation date: 19/05/2026 18:05

Check the most updated document online [click here](#)



### TECHNICAL DATA

Mod.	S2510 3/8-1/2
------	---------------

## Mod. S2510 - Sprint fittings Serie S2000

Product code: S2510 3/8-1/2

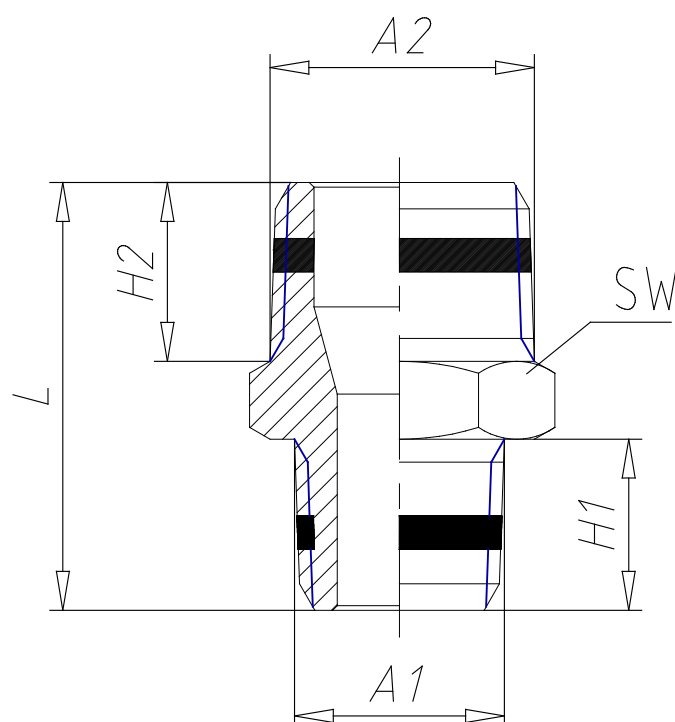

### DIMENSIONS

<b>A1</b>	R3/8
<b>A2</b>	R1/2
<b>H1 (mm)</b>	11.5
<b>H2 (mm)</b>	14.0
<b>L (mm)</b>	31.0
<b>SW (mm)</b>	22