

Mod. S2510 - Sprint fittings Serie S2000

Product code: S2510 1/8-3/8

Datasheet creation date: 19/05/2026 18:05

Check the most updated document online [click here](#)



TECHNICAL DATA

Mod.	S2510 1/8-3/8
------	---------------

Mod. S2510 - Sprint fittings Serie S2000

Product code: S2510 1/8-3/8

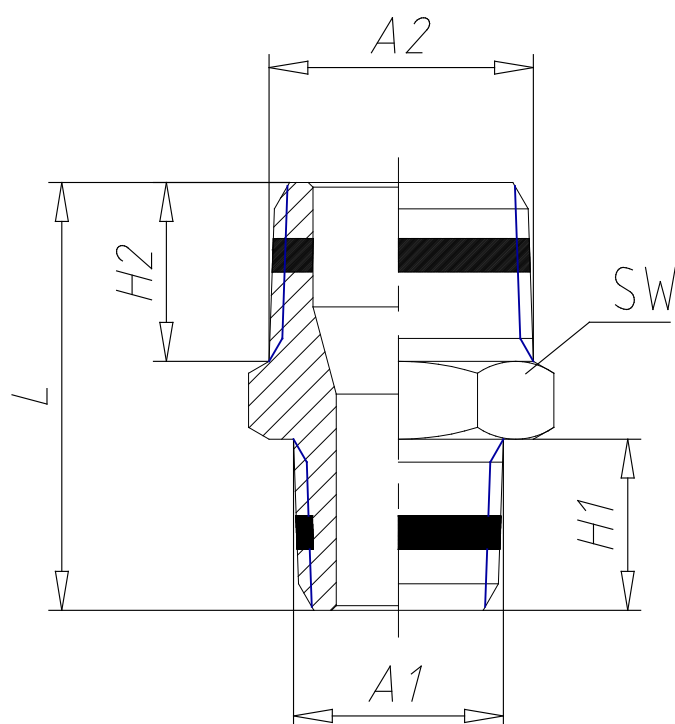

DIMENSIONS

A1	R1/8
A2	R3/8
H1 (mm)	7.5
H2 (mm)	11.5
L (mm)	24.0
SW (mm)	17