

Rod Lock - Series RL

Product code: RLC-41-80

Datasheet creation date: 19/05/2026 08:59

Check the most updated document online [click here](#)



TECHNICAL DATA

Mod.	RLC-41-80
Series	RCL= standard, complete with cartridge and housing
Cylinder Series	41
Diameter (mm)	80

Rod Lock - Series RL

Product code: RLC-41-80

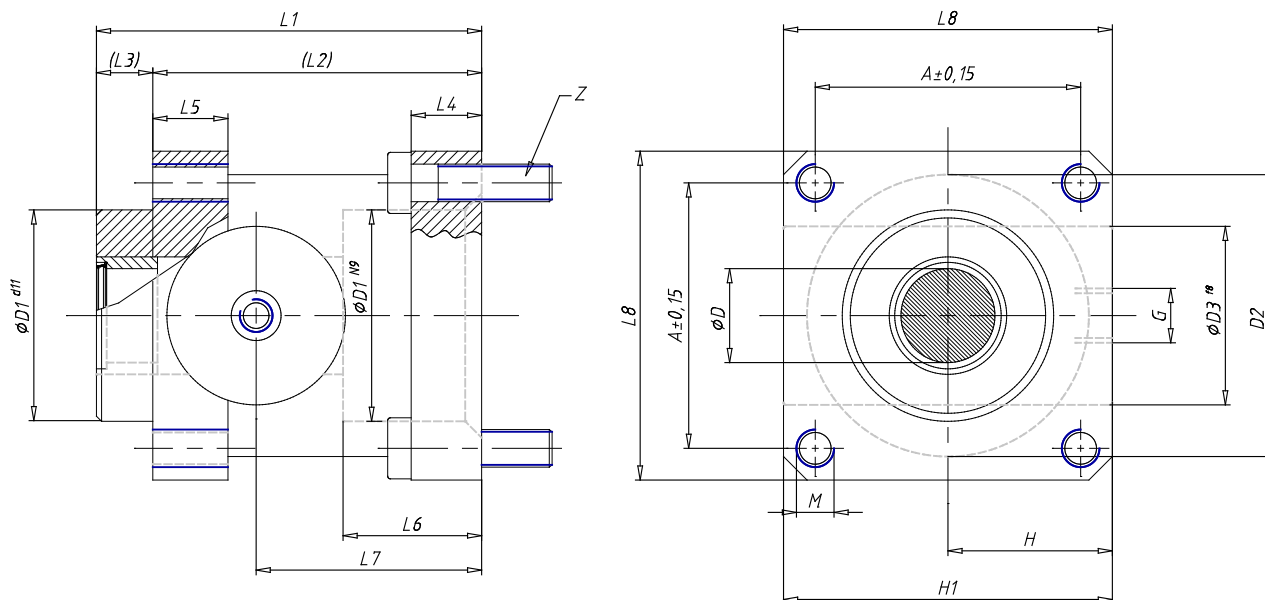

DIMENSIONS

D (mm)	25
A (mm)	72.0
D1 (mm)	45.0
D2 (mm)	80
D3 (mm)	48
G	G1/8
H (mm)	50.0
L (mm)	0
L1 (mm)	110
L2 (mm)	90
L3 (mm)	20
L4 (mm)	18
L5 (mm)	20
L6 (mm)	35.0
L7 (mm)	61.0
L8 (mm)	90
M	M10
H1 (mm)	95.0
Z	M10x35