

Rod Lock - Series RL

Product code: RLC-41-50

Datasheet creation date: 19/05/2026 08:44

Check the most updated document online [click here](#)



TECHNICAL DATA

Mod.	RLC-41-50
Series	RCL= standard, complete with cartridge and housing
Cylinder Series	41
Diameter (mm)	50

Rod Lock - Series RL

Product code: RLC-41-50

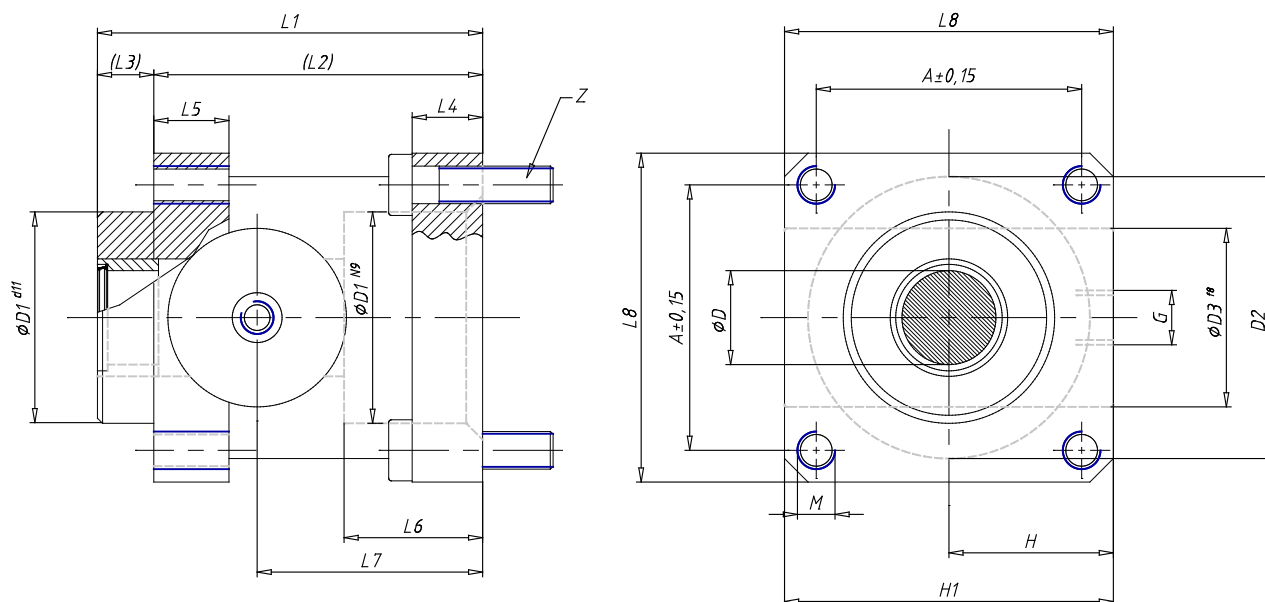

DIMENSIONS

D (mm)	20
A (mm)	46.5
D1 (mm)	40.0
D2 (mm)	50
D3 (mm)	35
G	G1/8
H (mm)	36.0
L (mm)	0
L1 (mm)	82
L2 (mm)	70
L3 (mm)	12
L4 (mm)	15
L5 (mm)	16
L6 (mm)	29.5
L7 (mm)	48.0
L8 (mm)	60
M	M8
H1 (mm)	64.0
Z	M8x30