

Rod Lock - Series RL

Product code: RLC-41-125

Datasheet creation date: 19/05/2026 08:45

Check the most updated document online [click here](#)



TECHNICAL DATA

Mod.	RLC-41-125
Series	RCL= standard, complete with cartridge and housing
Cylinder Series	41
Diameter (mm)	125

Rod Lock - Series RL

Product code: RLC-41-125

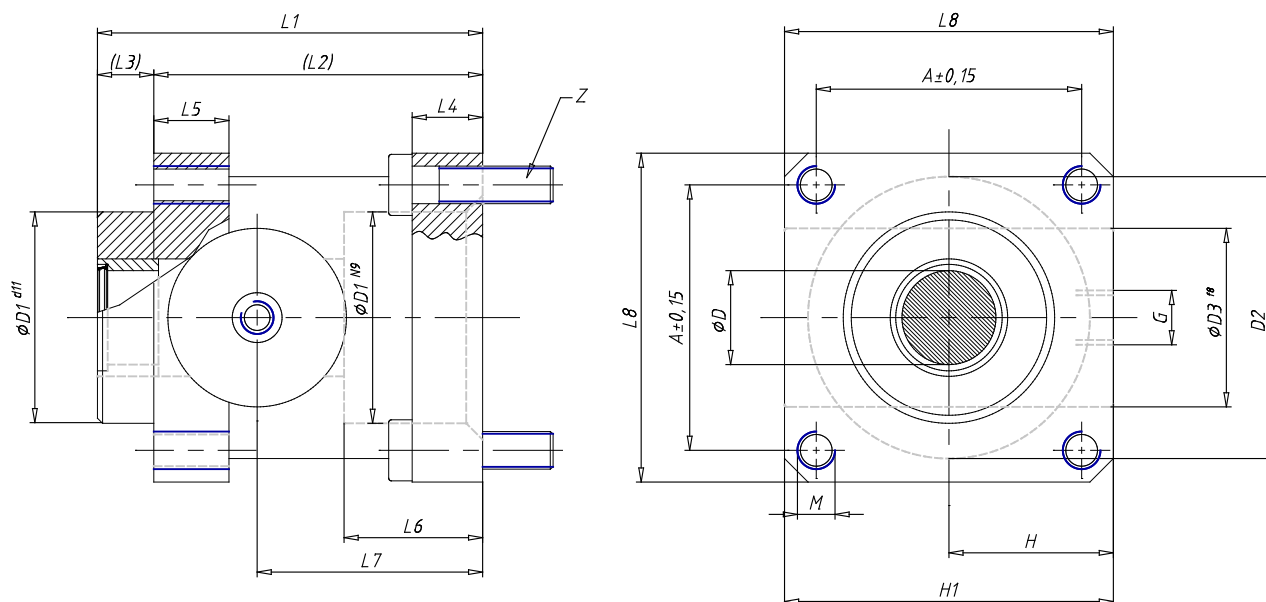

DIMENSIONS

D (mm)	32
A (mm)	110.0
D1 (mm)	60.0
D2 (mm)	130
D3 (mm)	65
G	G1/8
H (mm)	80.0
L (mm)	0
L1 (mm)	167
L2 (mm)	122
L3 (mm)	45
L4 (mm)	22
L5 (mm)	30
L6 (mm)	51.0
L7 (mm)	86.5
L8 (mm)	140
M	M12
H1 (mm)	150.0
Z	m12x40