

Unidirectional flow controller - Series RFU

Product code: RFU 477-1/2

Datasheet creation date: 19/05/2026 17:14

Check the most updated document online [click here](#)



TECHNICAL DATA

MOD (Mod.)	RFU 477-1/2
------------	-------------

Unidirectional flow controller - Series RFU

Product code: RFU 477-1/2

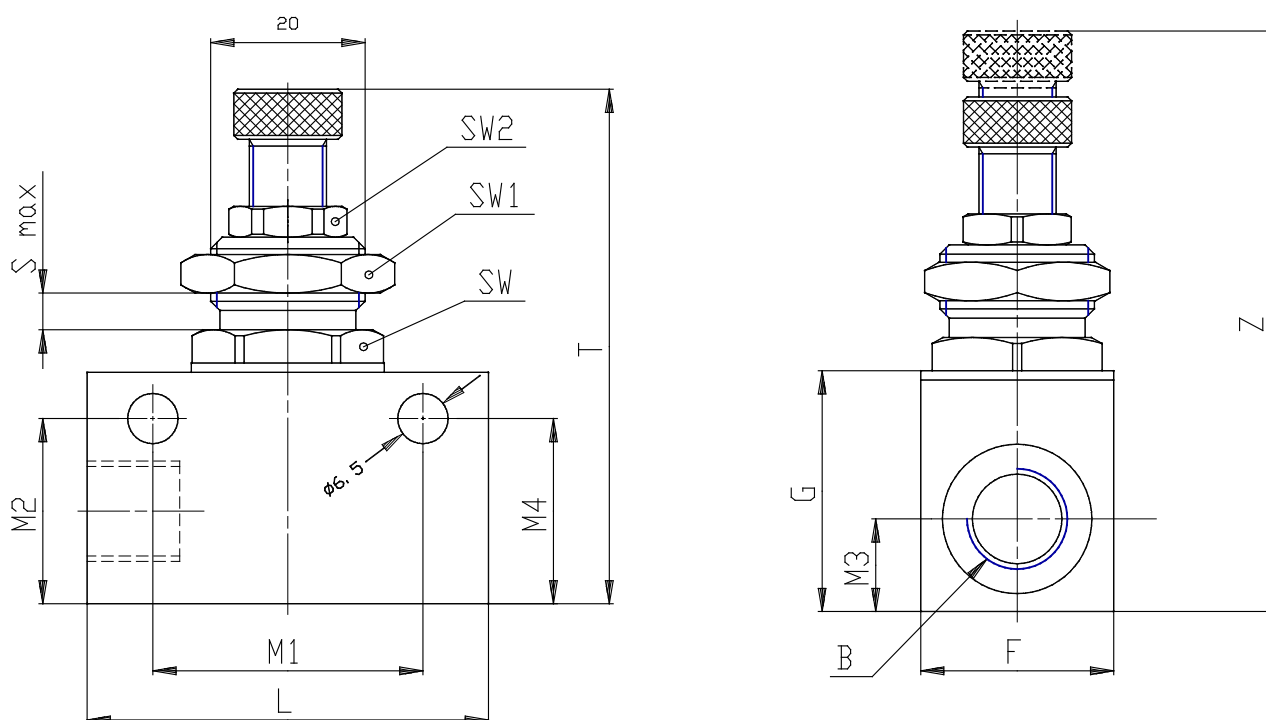

DIMENSIONS

PHYN (Ø / mm)	7.0
A (A)	M 18x1
B (B)	G1/2
D (D / mm)	6.5
F (F / mm)	27
G (G / mm)	42
L (L / mm)	56
M1 (M1 / mm)	43.0
M2 (M2 / mm)	34.5
M3 (M3 / mm)	28
M4 (M4 / mm)	7.5
T (T / mm)	75
Z (Z / mm)	85.0
S MAX (S MAX / mm)	8
SW (SW / mm)	22
SW1 (SW1 / mm)	22
SW2 (SW2 / mm)	0