

Bidirectional flow controller - Series RFO

Product code: RFO 367-3/8

Datasheet creation date: 19/05/2026 17:14

Check the most updated document online [click here](#)



TECHNICAL DATA

Mod.	RFO 367-3/8
------	-------------

Bidirectional flow controller - Series RFO

Product code: RFO 367-3/8

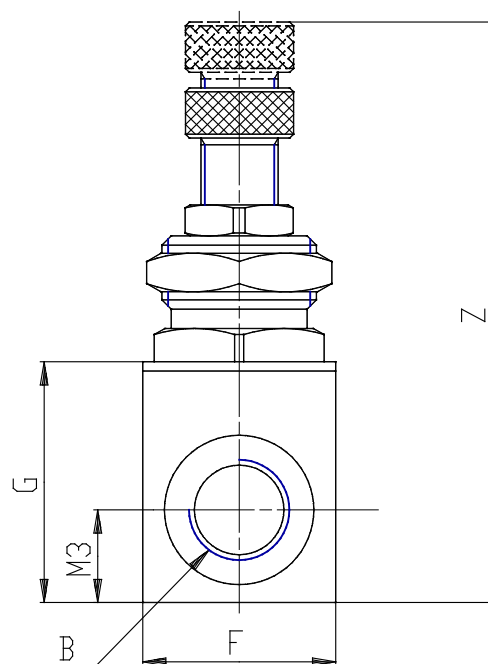
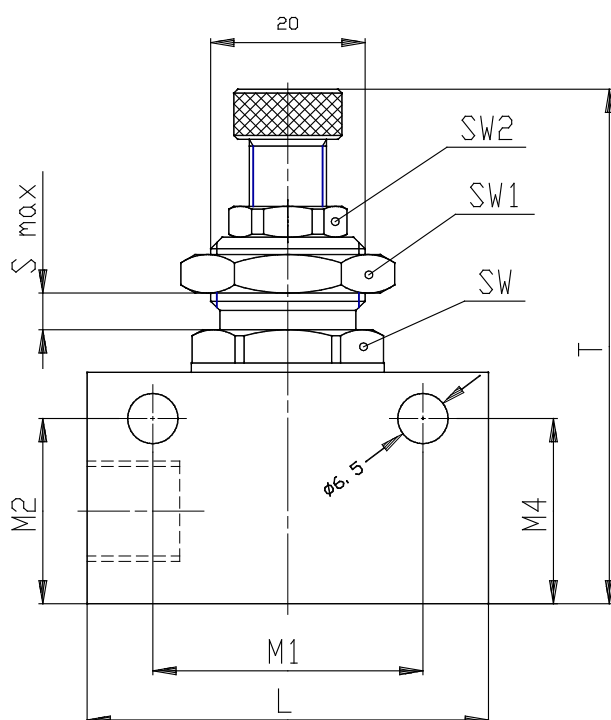

DIMENSIONS

Ø N (mm)	7.0
A	M 18x1
B	G3/8
D (mm)	6.5
F (mm)	27
G (mm)	42
L (mm)	56
M1 (mm)	43.0
M2 (mm)	34.5
M3 (mm)	28
M4 (mm)	7.5
T (mm)	75
Z (mm)	85.0
S MAX (mm)	8
SW (mm)	22
SW1 (mm)	22
SW2 (mm)	14