

## Short stroke magnetic cylinders - Series QP-QPR

Product code: QP2A032A030

Datasheet creation date: 19/05/2026 08:35

Check the most updated document online [click here](#)



### TECHNICAL DATA

<b>Series</b>	QP = standard
<b>Operation</b>	2=double-acting
<b>Materials</b>	A = rolled stainless steel
<b>Diameter (mm)</b>	32
<b>Construction</b>	A = standard
<b>Stroke (mm)</b>	30
<b>Seal options</b>	-
<b>Certifications</b>	= standard

## Short stroke magnetic cylinders - Series QP-QPR

Product code: QP2A032A030

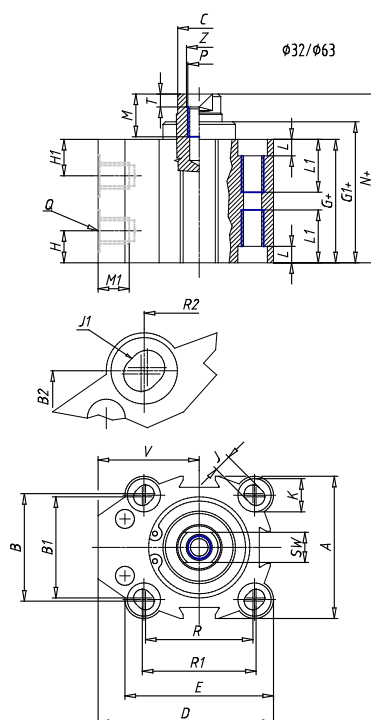

### DIMENSIONS

A (mm)	45.0
B (mm)	34.0
B1 (mm)	32
B2 (mm)	33
$\phi$ C (mm)	12
D (mm)	55.50
E (mm)	47.00
G (mm)	39.5
G1 (mm)	40
H1 (mm)	9.5
H (mm)	9.5
J (mm)	5.5
J1	M8
K (mm)	10.5
L (mm)	6.0
L1 (mm)	21.0
M (mm)	10.0
M1 (mm)	7.5
N (mm)	44.0
N1 (mm)	-
$\phi$ O (mm)	23.5
P	M6
Q	G1/8

R (mm)	34.0
R1 (mm)	36.00
R2 (mm)	35
SW (mm)	10
T (mm)	2.5
U (mm)	-
V (mm)	32.00
AA (mm)	10
BB (mm)	6.0
$\phi$ CC (mm)	9.0
$\phi$ DD (mm)	5.5
EE (mm)	9.0
FF	M5
LL (mm)	32.0
MM (mm)	47.0
NN (mm)	45
RR (mm)	36.0
VV (mm)	-
Z (mm)	7.0