

Short stroke magnetic cylinders - Series QP-QPR

Product code: QP2A032A015

Datasheet creation date: 19/05/2026 08:35

Check the most updated document online [click here](#)



TECHNICAL DATA

Series	QP = standard
Operation	2=double-acting
Materials	A = rolled stainless steel
Diameter (mm)	32
Construction	A = standard
Stroke (mm)	15
Seal options	-
Certifications	= standard

Short stroke magnetic cylinders - Series QP-QPR

Product code: QP2A032A015

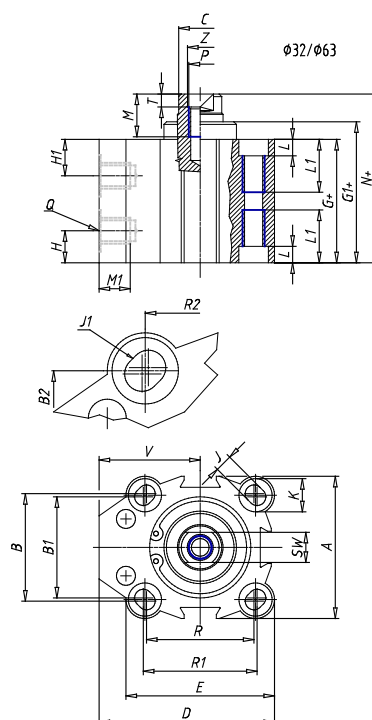

DIMENSIONS

A (mm)	45.0
B (mm)	34.0
B1 (mm)	32
B2 (mm)	33
ϕ C (mm)	12
D (mm)	55.50
E (mm)	47.00
G (mm)	39.5
G1 (mm)	40
H1 (mm)	9.5
H (mm)	9.5
J (mm)	5.5
J1	M8
K (mm)	10.5
L (mm)	6.0
L1 (mm)	21.0
M (mm)	10.0
M1 (mm)	7.5
N (mm)	44.0
N1 (mm)	-
ϕ O (mm)	23.5
P	M6
Q	G1/8

R (mm)	34.0
R1 (mm)	36.00
R2 (mm)	35
SW (mm)	10
T (mm)	2.5
U (mm)	-
V (mm)	32.00
AA (mm)	10
BB (mm)	6.0
ϕ CC (mm)	9.0
ϕ DD (mm)	5.5
EE (mm)	9.0
FF	M5
LL (mm)	32.0
MM (mm)	47.0
NN (mm)	45
RR (mm)	36.0
VV (mm)	-
Z (mm)	7.0