

## Short stroke magnetic cylinders - Series QP-QPR

Product code: QP2A032A005

Datasheet creation date: 19/05/2026 08:34

Check the most updated document online [click here](#)



### TECHNICAL DATA

<b>Series</b>	QP = standard
<b>Operation</b>	2=double-acting
<b>Materials</b>	A = rolled stainless steel
<b>Diameter (mm)</b>	32
<b>Construction</b>	A = standard
<b>Stroke (mm)</b>	5
<b>Seal options</b>	-
<b>Certifications</b>	= standard

## Short stroke magnetic cylinders - Series QP-QPR

Product code: QP2A032A005

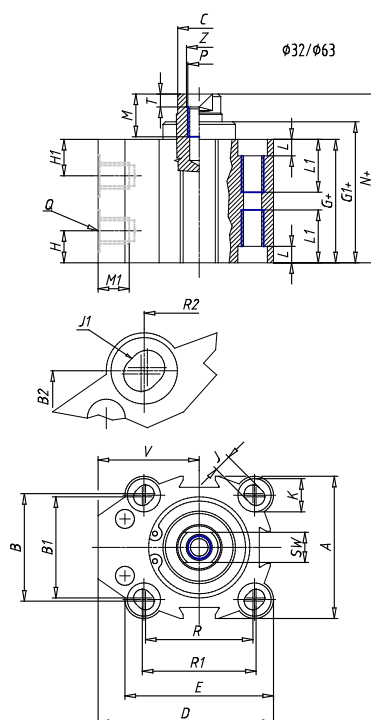

### DIMENSIONS

<b>A (mm)</b>	45.0
<b>B (mm)</b>	34.0
<b>B1 (mm)</b>	32
<b>B2 (mm)</b>	33
<b>Ø C (mm)</b>	12
<b>D (mm)</b>	55.50
<b>E (mm)</b>	47.00
<b>G (mm)</b>	39.5
<b>G1 (mm)</b>	40
<b>H1 (mm)</b>	9.5
<b>H (mm)</b>	9.5
<b>J (mm)</b>	5.5
<b>J1</b>	M8
<b>K (mm)</b>	10.5
<b>L (mm)</b>	6.0
<b>L1 (mm)</b>	21.0
<b>M (mm)</b>	10.0
<b>M1 (mm)</b>	7.5
<b>N (mm)</b>	44.0
<b>N1 (mm)</b>	-
<b>Ø O (mm)</b>	23.5
<b>P</b>	M6
<b>Q</b>	G1/8

<b>R (mm)</b>	34.0
<b>R1 (mm)</b>	36.00
<b>R2 (mm)</b>	35
<b>SW (mm)</b>	10
<b>T (mm)</b>	2.5
<b>U (mm)</b>	-
<b>V (mm)</b>	32.00
<b>AA (mm)</b>	10
<b>BB (mm)</b>	6.0
<b>Ø CC (mm)</b>	9.0
<b>Ø DD (mm)</b>	5.5
<b>EE (mm)</b>	9.0
<b>FF</b>	M5
<b>LL (mm)</b>	32.0
<b>MM (mm)</b>	47.0
<b>NN (mm)</b>	45
<b>RR (mm)</b>	36.0
<b>VV (mm)</b>	-
<b>Z (mm)</b>	7.0