

## Series QN - Short-stroke cylinders

Product code: QN1A20A04

Datasheet creation date: 19/05/2026 08:56

Check the most updated document online [click here](#)



### TECHNICAL DATA

<b>SERIE (Series)</b>	QN
<b>FUNZIONE (Operation)</b>	1 = single acting
<b>MATERIALI (Materials)</b>	A = rolled stainless steel rod - aluminium body
<b>PHY (Diameter / mm)</b>	20
<b>TIPOCOSTRUT (Construction)</b>	A = standard
<b>HUB (Stroke / mm)</b>	4
<b>CERTIFICAZIONI (Certifications)</b>	= standard

## Series QN - Short-stroke cylinders

Product code: QN1A20A04

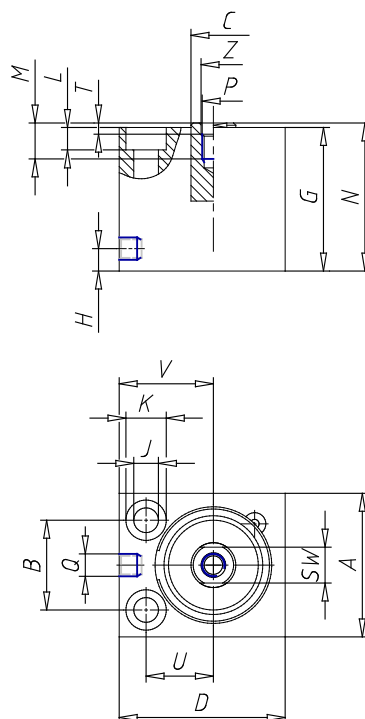

### DIMENSIONS

A (mm)	32
B (mm)	20
Ø C (mm)	10
D (mm)	37
E (mm)	37.0
F (mm)	-
G (mm)	20.0
H (mm)	5.0
Ø J (mm)	5.5
Ø K (mm)	9.0
L (mm)	5.0
M (mm)	8
N (mm)	21.0
P	M5
Q	M5
R (mm)	-
SW (mm)	8
T (mm)	2.5
U (mm)	15
V (mm)	21.0
Z (mm)	5.5