

## Series QN - Short-stroke cylinders

Product code: QN1A08A04

Datasheet creation date: 19/05/2026 09:06

Check the most updated document online [click here](#)



### TECHNICAL DATA

<b>SERIE (Series)</b>	QN
<b>FUNZIONE (Operation)</b>	1 = single acting
<b>MATERIALI (Materials)</b>	A = rolled stainless steel rod - aluminium body
<b>PHY (Diameter / mm)</b>	8
<b>TIPOCOSTRUT (Construction)</b>	A = standard
<b>HUB (Stroke / mm)</b>	4
<b>CERTIFICAZIONI (Certifications)</b>	= standard

## Series QN - Short-stroke cylinders

Product code: QN1A08A04

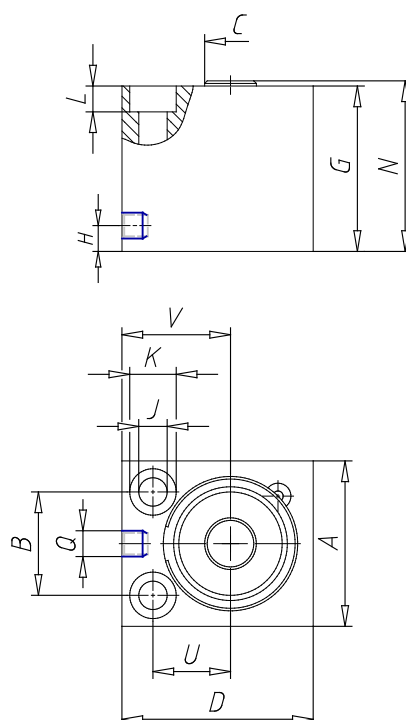

### DIMENSIONS

A (mm)	18
B (mm)	11
Ø C (mm)	4
D (mm)	20
E (mm)	20.0
F (mm)	-
G (mm)	16.0
H (mm)	5.0
Ø J (mm)	3.2
Ø K (mm)	5.8
L (mm)	3.0
M (mm)	-
N (mm)	17.0
P	-
Q	M5
R (mm)	-
SW (mm)	-
T (mm)	-
U (mm)	8
V (mm)	13.5
Z (mm)	-