

Cylinders with integrated guide - Series QCT QCB

Product code: QCT2A020A075

Datasheet creation date: 19/05/2026 08:35

Check the most updated document online [click here](#)



TECHNICAL DATA

SERIE (Series)	QC
VERSION (Version)	T = sintered bronze bushes
FUNZ (Operation)	2 = double acting
MAT (Materials)	A = anodized aluminium body, rolled stainless steel 303 piston rod, rolled stainless steel 420B columns for QTC
PHY (Diameter / mm)	20
TYP (Construction)	A = standard
HUB (Stroke / mm)	75
ATEX (Certifications)	= standard

Cylinders with integrated guide - Series QCT QCB

Product code: QCT2A020A075

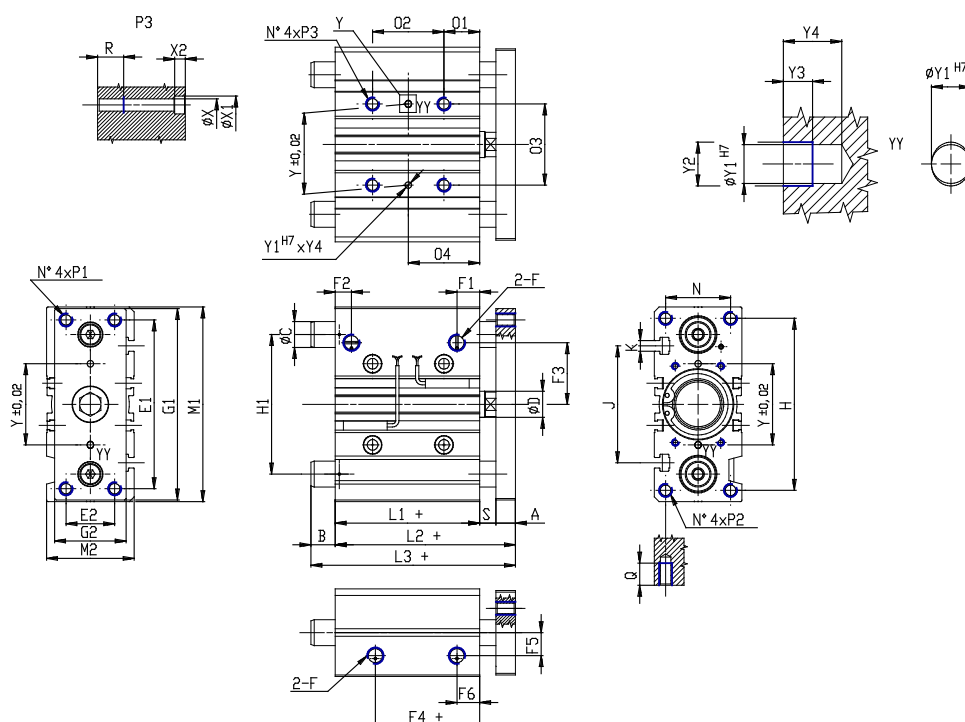

DIMENSIONS

L3 (mm)	79.5
C (mm)	12
B (mm)	26.5
O2 (mm)	44
O4 (mm)	39
A (mm)	10
D (mm)	10
E1 (mm)	70
E2 (mm)	18
F	G 1/8
F1 (mm)	10.5
F2 (mm)	10.5
F3 (mm)	25.0
F4 (mm)	12.5
F5 (mm)	11.5
F6 (mm)	10.5
G1 (mm)	81
G2 (mm)	30
H (mm)	72
H1 (mm)	54
L1 (mm)	37.0
L2 (mm)	53.0
M1 (mm)	83

M2 (mm)	36
N (mm)	24
O1 (mm)	17
O3 (mm)	28
P1	M5x0.8
P2	M5x0.8
P3	M6x1
Q (mm)	13
R (mm)	12
heavy (mm)	6
Y (mm)	28
Y1 (mm)	3
Y2 (mm)	3.5
Y3 (mm)	3
Y4 (mm)	6
X (mm)	5.5
X1 (mm)	9
X2 (mm)	5.0
J (mm)	44
K	M5