

Foot mount/flange - Mod. P

Product code: P-42-32

Datasheet creation date: 19/05/2026 08:30

Check the most updated document online [click here](#)



TECHNICAL DATA

Mod.	P-42-32
------	---------

Foot mount/flange - Mod. P

Product code: P-42-32

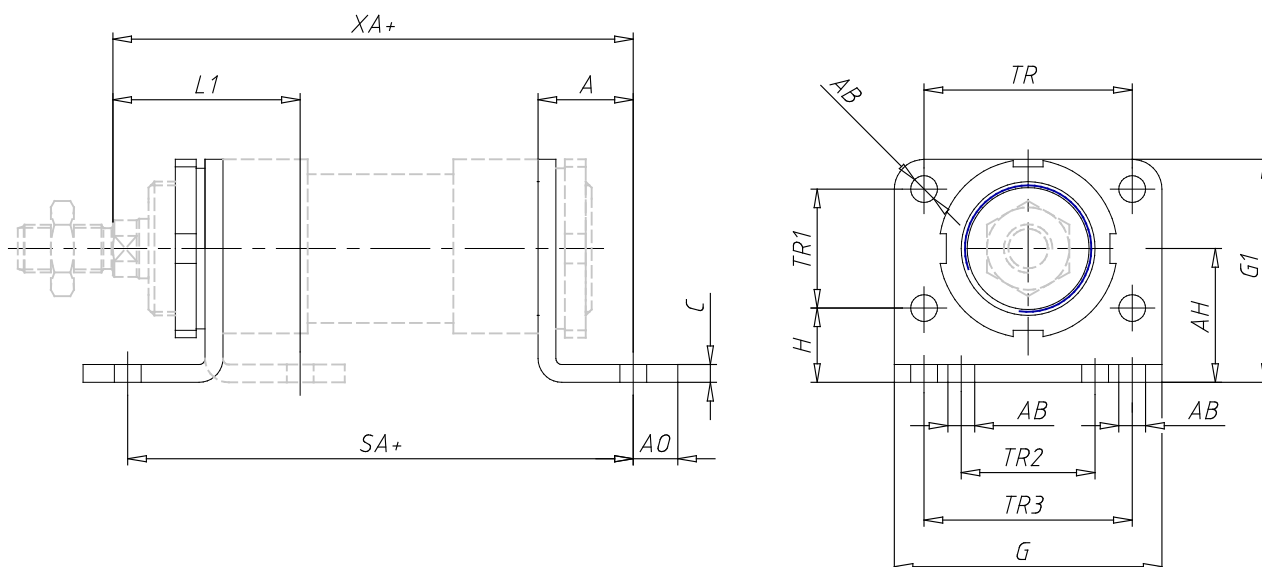

DIMENSIONS

L1 (mm)	46
SA (mm)	142
XA (mm)	144
A (mm)	24
AB (mm)	7
AO (mm)	11
AH (mm)	32
C (mm)	4
G (mm)	66
G1 (mm)	53
TR (mm)	52
TR1 (mm)	28
TR2 (mm)	32
TR3 (mm)	52
H (mm)	18