

5/2-way solenoid valve, monostable - Series NA

Product code: NA54N-15-02

Datasheet creation date: 19/05/2026 08:48

Check the most updated document online [click here](#)



■ TECHNICAL DATA

Mod.	NA54N-15-02
------	-------------

5/2-way solenoid valve, monostable - Series NA

Product code: NA54N-15-02

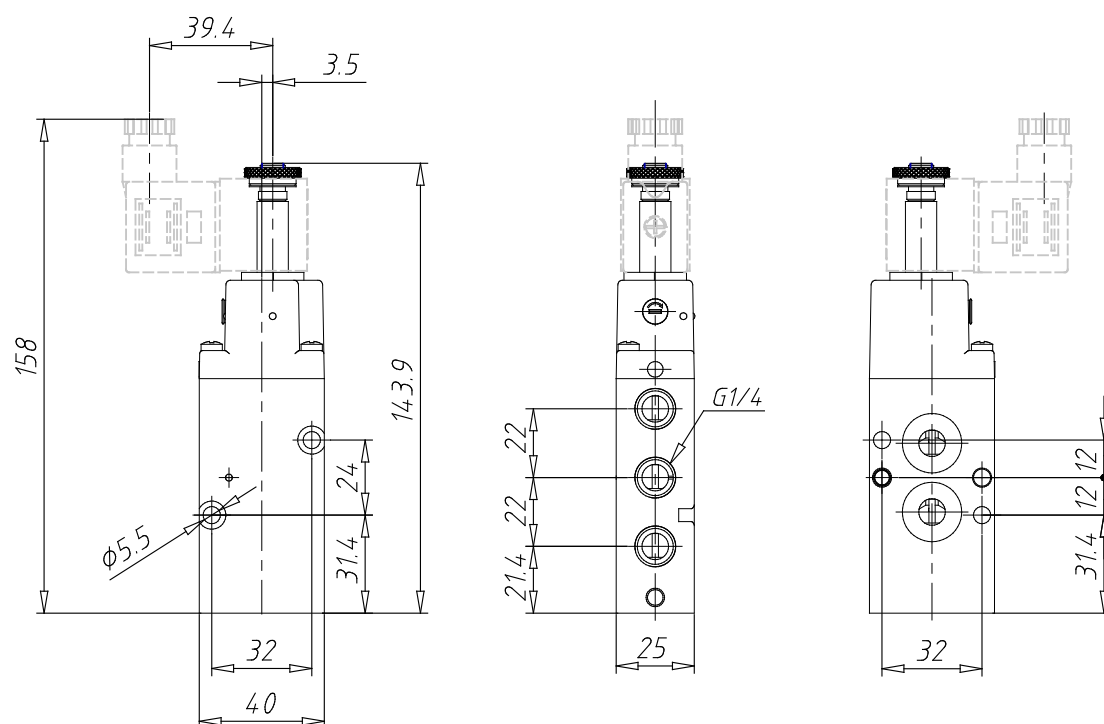

DIMENSIONS

Mod.	NA54N-15-02
------	-------------