

Isolation 3/2-way valves - Series MX

Product code: MX3-1-V16

Datasheet creation date: 19/05/2026 09:00

Check the most updated document online [click here](#)



TECHNICAL DATA

Series	MX
Size	3
Ports (IN - OUT)	1 = G1
3/2-way valve	V
Design type	16 = electro-pneumatic control
Flow direction	= from left to right (standard)

Isolation 3/2-way valves - Series MX

Product code: MX3-1-V16

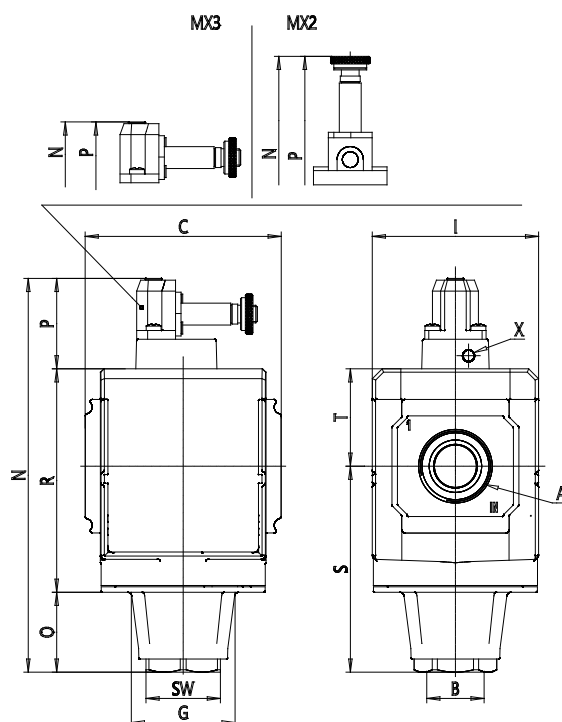

DIMENSIONS

	G1
(mm)	G 3/4
(mm)	89.5
(mm)	-
(mm)	48.0
(mm)	76
(mm)	-
(mm)	-
(mm)	180.5
(mm)	37
(mm)	41.5
(mm)	-
(mm)	102
(mm)	94.5
(mm)	34
(mm)	44.5
	-
Y (piloting)	-
Weight (kg)	0.9