

Isolation 3/2-way valves - Series MX

Product code: MX3-1-V01

Datasheet creation date: 19/05/2026 08:51

Check the most updated document online [click here](#)



TECHNICAL DATA

Series	MX
Size	3
Ports (IN - OUT)	1 = G1
3/2-way valve	V
Design type	01 = lockable manual control
Flow direction	= from left to right (standard)

Isolation 3/2-way valves - Series MX

Product code: MX3-1-V01

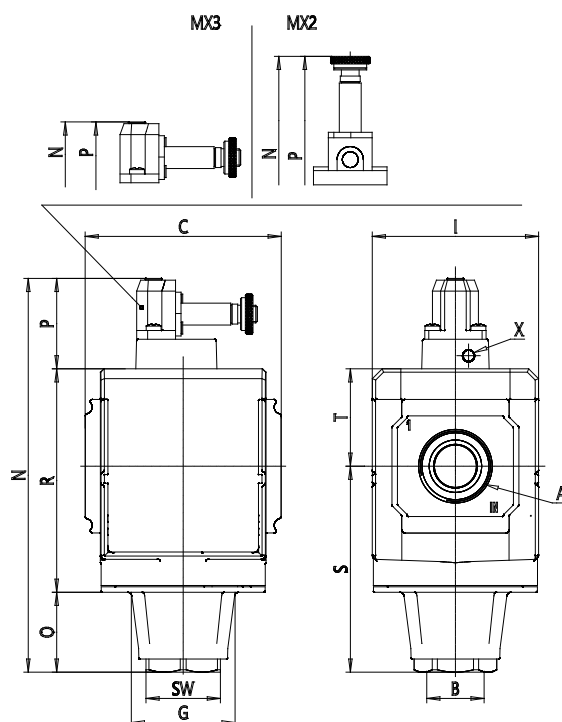

DIMENSIONS

	G1
(mm)	G 3/4
(mm)	89.5
(mm)	32
(mm)	48.0
(mm)	76
(mm)	8
(mm)	14.5
(mm)	205.5
(mm)	37
(mm)	66.5
(mm)	40
(mm)	102
(mm)	94.5
(mm)	34
(mm)	44.5
	-
Y (piloting)	-
Weight (kg)	0.9