

Isolation 3/2-way valves - Series MX

Product code: MX2-3/4-V01

Datasheet creation date: 19/05/2026 17:41

Check the most updated document online [click here](#)



TECHNICAL DATA

Series	MX
Size	2
Ports (IN - OUT)	3/4 = G3/4
3/2-way valve	V
Design type	01 = lockable manual control
Flow direction	= from left to right (standard)

Isolation 3/2-way valves - Series MX

Product code: MX2-3/4-V01

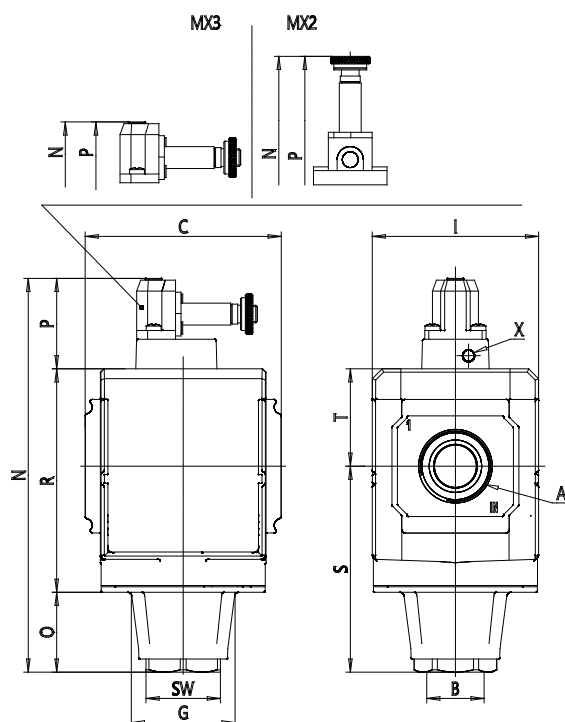

DIMENSIONS

	G3/4
(mm)	G 1/2
(mm)	70.0
(mm)	26
(mm)	34.5
(mm)	68
(mm)	9
(mm)	8
(mm)	152.0
(mm)	13
(mm)	51.0
(mm)	31
(mm)	88
(mm)	63.5
(mm)	27
(mm)	37.5
	-
Y (piloting)	-
Weight (kg)	0.5