

Isolation 3/2-way valves - Series MX

Product code: MX2-1/2-V16

Datasheet creation date: 19/05/2026 08:51

Check the most updated document online [click here](#)



TECHNICAL DATA

Series	MX
Size	2
Ports (IN - OUT)	1/2 = G1/2
3/2-way valve	V
Design type	16 = electro-pneumatic control
Flow direction	= from left to right (standard)

Isolation 3/2-way valves - Series MX

Product code: MX2-1/2-V16

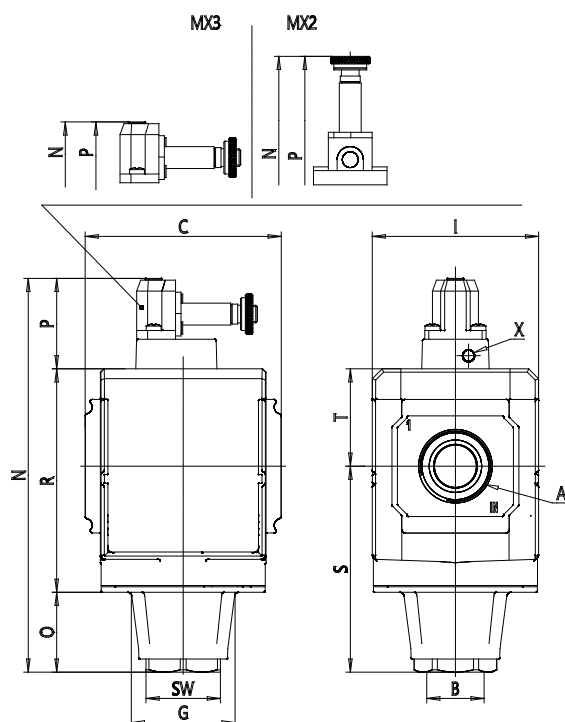

DIMENSIONS

	G1/2
(mm)	G 1/2
(mm)	70.0
(mm)	-
(mm)	34.5
(mm)	68
(mm)	-
(mm)	-
(mm)	171.0
(mm)	13
(mm)	70.0
(mm)	-
(mm)	88
(mm)	63.5
(mm)	27
(mm)	37.5
	-
Y (piloting)	-
Weight (kg)	0.5