

## Regulators - Series MC

Product code: MC202-R10

Datasheet creation date: 19/05/2026 18:15

Check the most updated document online [click here](#)



### TECHNICAL DATA

Mod.	MC202-R10
U	G1/2

## Regulators - Series MC

Product code: MC202-R10

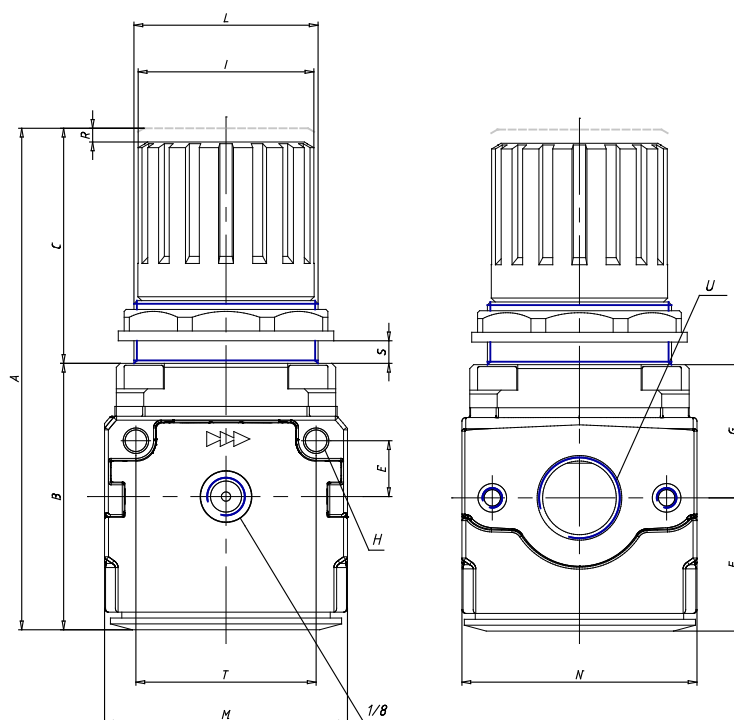

### DIMENSIONS

<b>A (mm)</b>	127
<b>B (mm)</b>	67
<b>C (mm)</b>	60
<b>E (mm)</b>	14
<b>F (mm)</b>	34.0
<b>G (mm)</b>	35.0
<b>H (mm)</b>	5.5
<b>I (mm)</b>	45
<b>L</b>	47x1.5
<b>M (mm)</b>	62
<b>N (mm)</b>	60
<b>R (mm)</b>	3.5
<b>S</b>	0:9
<b>T (mm)</b>	46