

## Soft Start valve - Series MC

Product code: MC202-AV

Datasheet creation date: 19/05/2026 17:29

Check the most updated document online [click here](#)



### TECHNICAL DATA

Mod. (mm)	MC202-AV
U	G1/2

## Soft Start valve - Series MC

Product code: MC202-AV

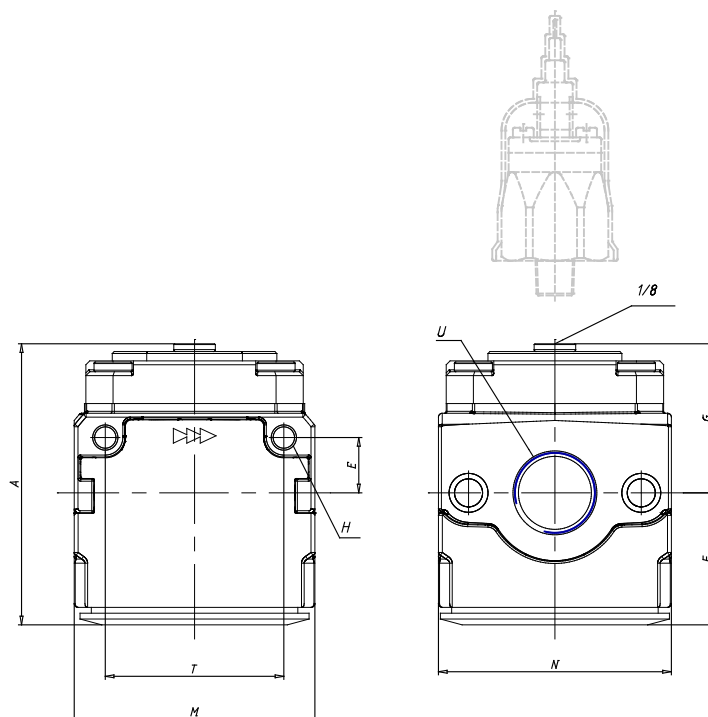

### DIMENSIONS

<b>A (mm)</b>	72.5
<b>E (mm)</b>	14
<b>F (mm)</b>	34.0
<b>G (mm)</b>	38.5
<b>H (mm)</b>	5.5
<b>M (mm)</b>	62
<b>N (mm)</b>	60
<b>T (mm)</b>	46