

Isolation valve 3/2 electric/pneumatic MC - Serie MC

Product code: MC104-V16

Datasheet creation date: 19/05/2026 08:51

Check the most updated document online [click here](#)



TECHNICAL DATA

Mod.	MC104-V16
U	G1/4

Isolation valve 3/2 electric/pneumatic MC - Serie MC

Product code: MC104-V16

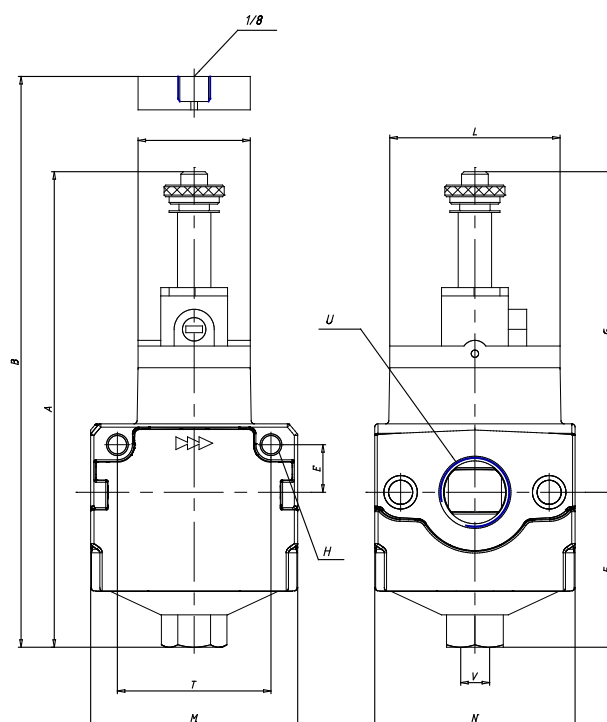

DIMENSIONS

A (mm)	120.0
B (mm)	-
E (mm)	11
F (mm)	38.5
G (mm)	81.5
H (mm)	4.5
I (mm)	22.0
L (mm)	32
M (mm)	45
N (mm)	45
T (mm)	35
V	G1/8