

Soft Start valve - Series MC

Product code: MC104-AV

Datasheet creation date: 19/05/2026 08:51

Check the most updated document online [click here](#)



TECHNICAL DATA

Mod. (mm)	MC104-AV
U	G1/4

Soft Start valve - Series MC

Product code: MC104-AV

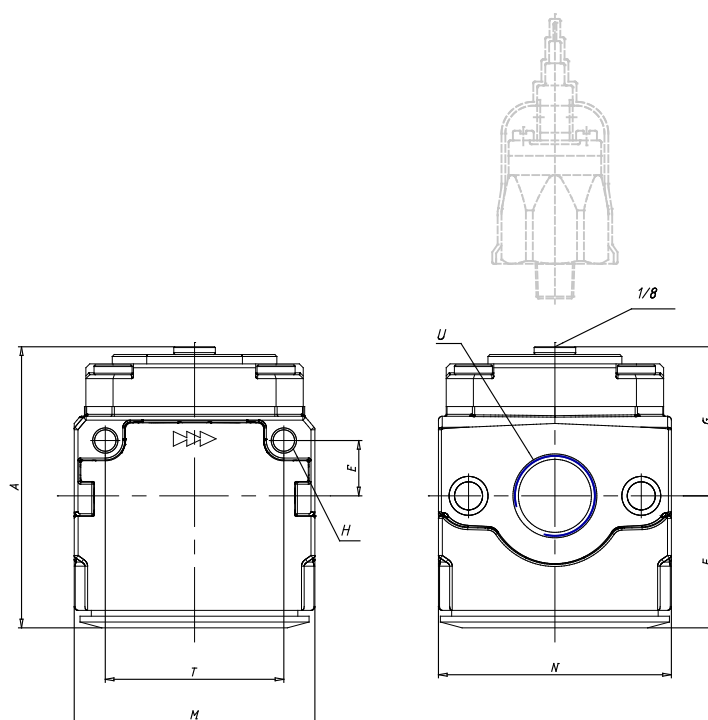

DIMENSIONS

A (mm)	59.5
E (mm)	11
F (mm)	28.5
G (mm)	31.0
H (mm)	4.5
M (mm)	45
N (mm)	45
T (mm)	35