

Take off block - Series MC

Product code: MC1-B

Datasheet creation date: 20/05/2026 03:59

Check the most updated document online [click here](#)



TECHNICAL DATA

Mod.	MC1-B
U	1/4

Take off block - Series MC

Product code: MC1-B

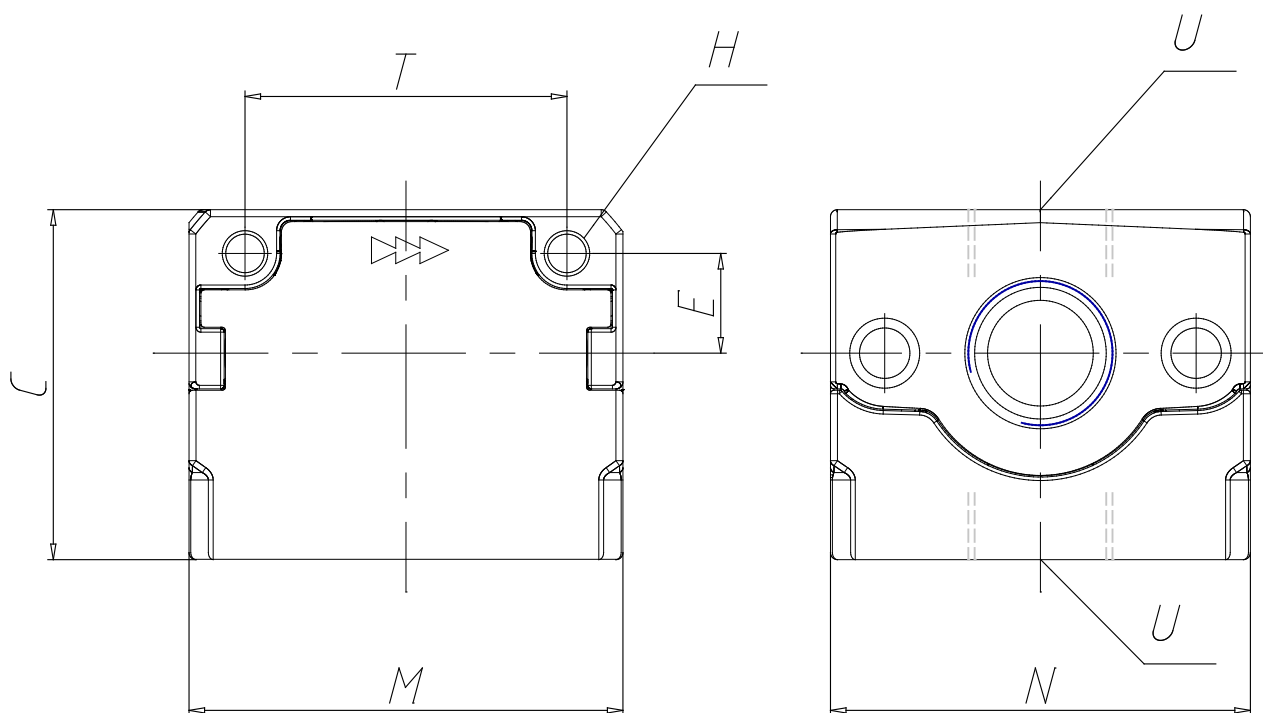

DIMENSIONS

C (mm)	43
H (mm)	4.5
E (mm)	11
M (mm)	45
N (mm)	45
T (mm)	35