

- Pressure gauges with rear connection

Product code: M053-P12

Datasheet creation date: 19/05/2026 08:54

Check the most updated document online [click here](#)



■ TECHNICAL DATA

Mod.	M053-P12
------	----------

- Pressure gauges with rear connection

Product code: M053-P12

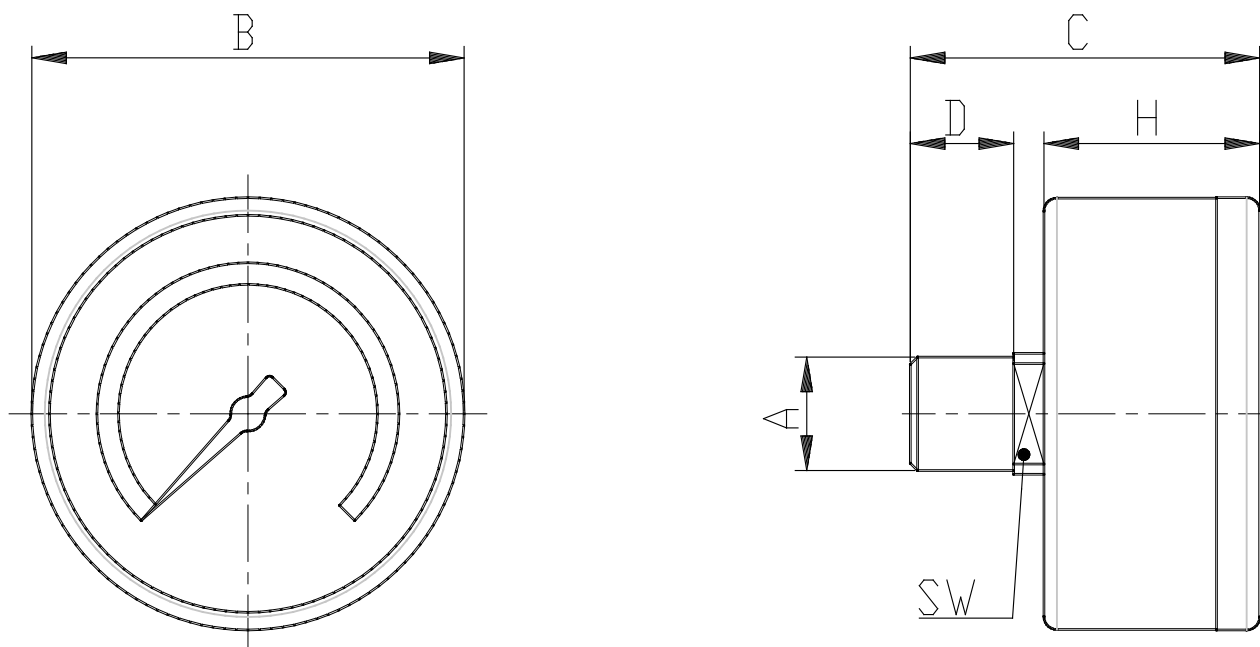

■ DIMENSIONS

A	R1/8
B (mm)	50.000
C (mm)	41.500
D (mm)	10.000
H (mm)	25.000
SW (mm)	14.000
R (bar)	0-12 bar