

## - Pressure gauges with rear connection

Product code: M053-P10

Datasheet creation date: 19/05/2026 09:00

Check the most updated document online [click here](#)



### ■ TECHNICAL DATA

Mod.	M053-P10
------	----------

## - Pressure gauges with rear connection

Product code: M053-P10

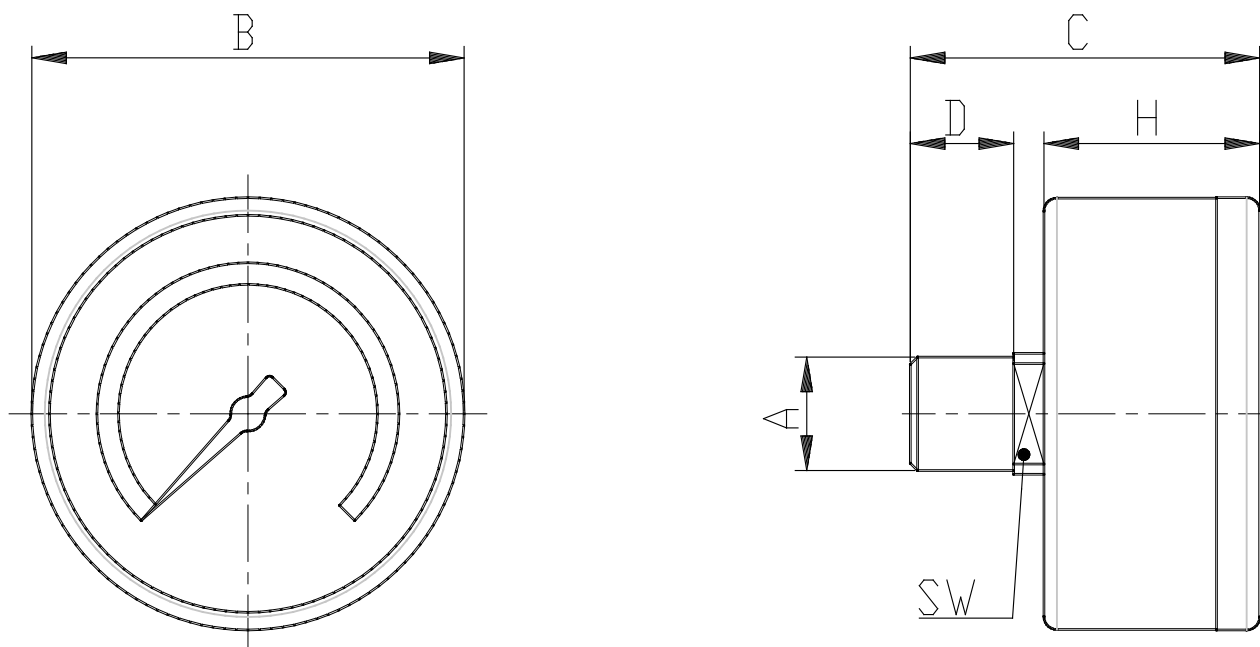

### ■ DIMENSIONS

<b>A</b>	R1/8
<b>B (mm)</b>	50.000
<b>C (mm)</b>	41.500
<b>D (mm)</b>	10.000
<b>H (mm)</b>	25.000
<b>SW (mm)</b>	14.000
<b>R (bar)</b>	0-10 bar