

Rear trunnion - Mod. I

Product code: I-42-63

Datasheet creation date: 19/05/2026 08:31

Check the most updated document online [click here](#)

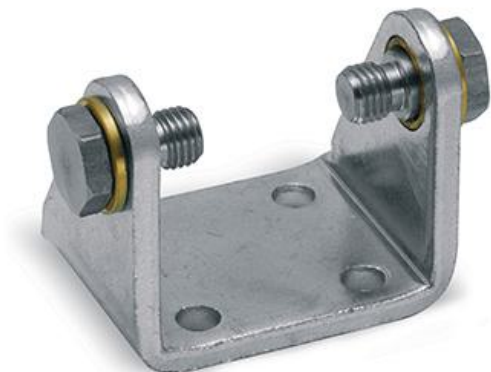

TECHNICAL DATA

Mod.	I-42-63
------	---------

Rear trunnion - Mod. I

Product code: I-42-63

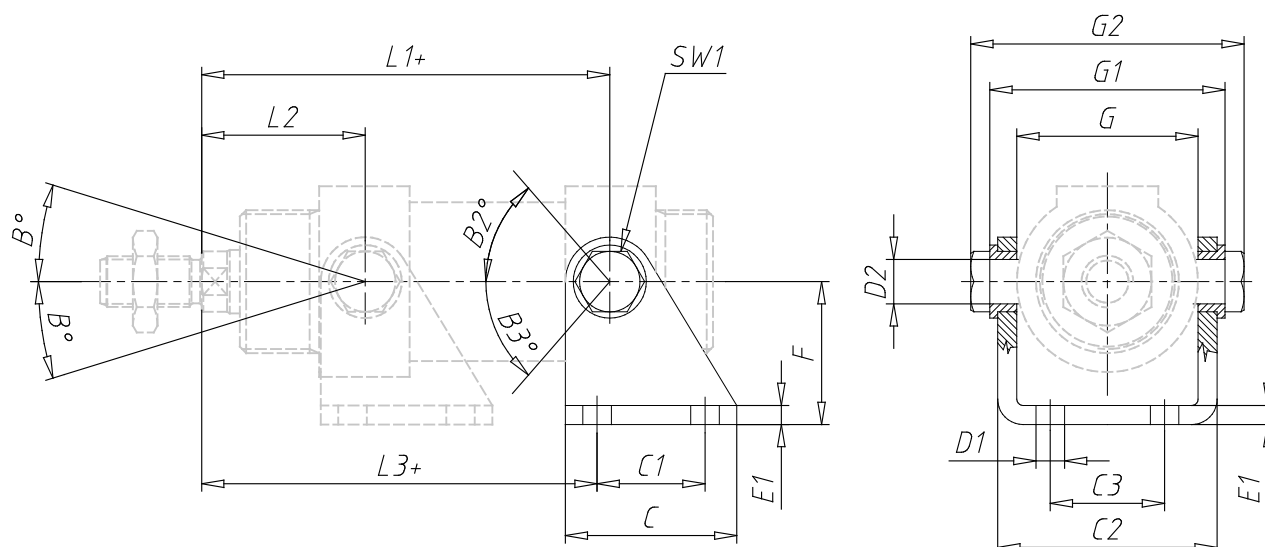

DIMENSIONS

L1 (mm)	143.0
L2 (mm)	52.0
L3 (mm)	142.0
C (mm)	65
C1 (mm)	35
C2 (mm)	82.1
C3 (mm)	42
D1 (mm)	9
D2 (mm)	16
E1 (mm)	6
F (mm)	50
SW1 (mm)	19
G (mm)	70.1
G1 (mm)	88.1
G2 (mm)	100.1