

Rear trunnion - Mod. I

Product code: I-42-40

Datasheet creation date: 19/05/2026 08:30

Check the most updated document online [click here](#)

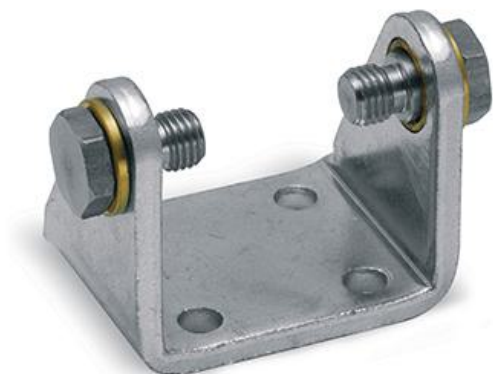

TECHNICAL DATA

Mod.	I-42-40
------	---------

Rear trunnion - Mod. I

Product code: I-42-40

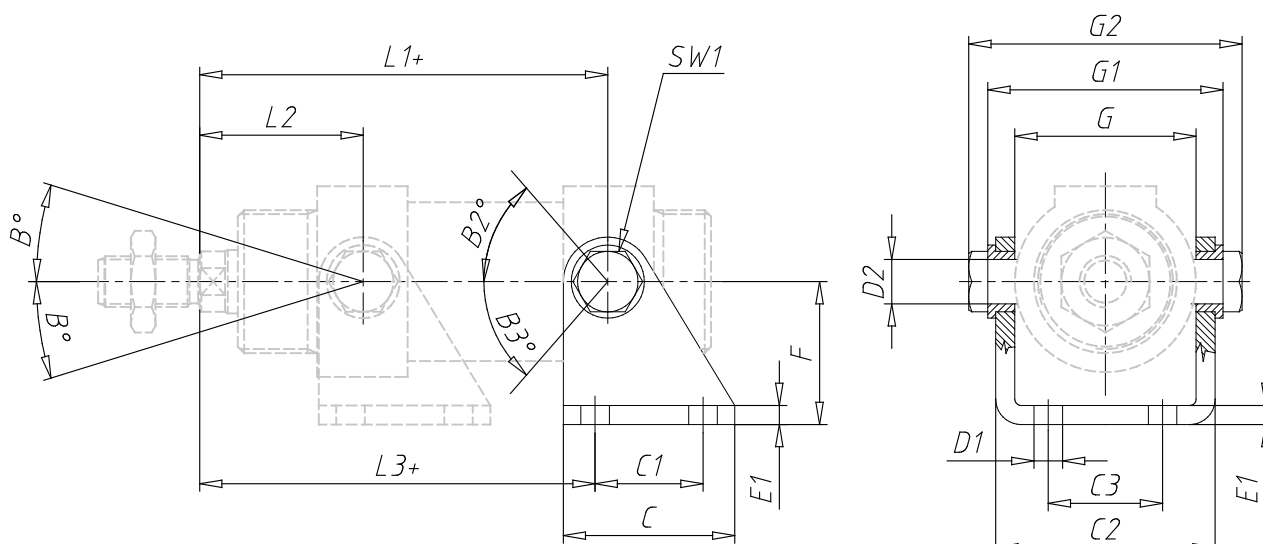

DIMENSIONS

L1 (mm)	120.0
L2 (mm)	45.0
L3 (mm)	117.0
C (mm)	50
C1 (mm)	30
C2 (mm)	56.1
C3 (mm)	28
D1 (mm)	9
D2 (mm)	12
E1 (mm)	5
F (mm)	40
SW1 (mm)	17
G (mm)	46.1
G1 (mm)	60.1
G2 (mm)	70.1