

Rear Trunnion bracket - Mod. I

Product code: I-27-50

Datasheet creation date: 19/05/2026 08:31

Check the most updated document online [click here](#)



■ TECHNICAL DATA

Mod.	I-27-50
------	---------

Rear Trunnion bracket - Mod. I

Product code: I-27-50

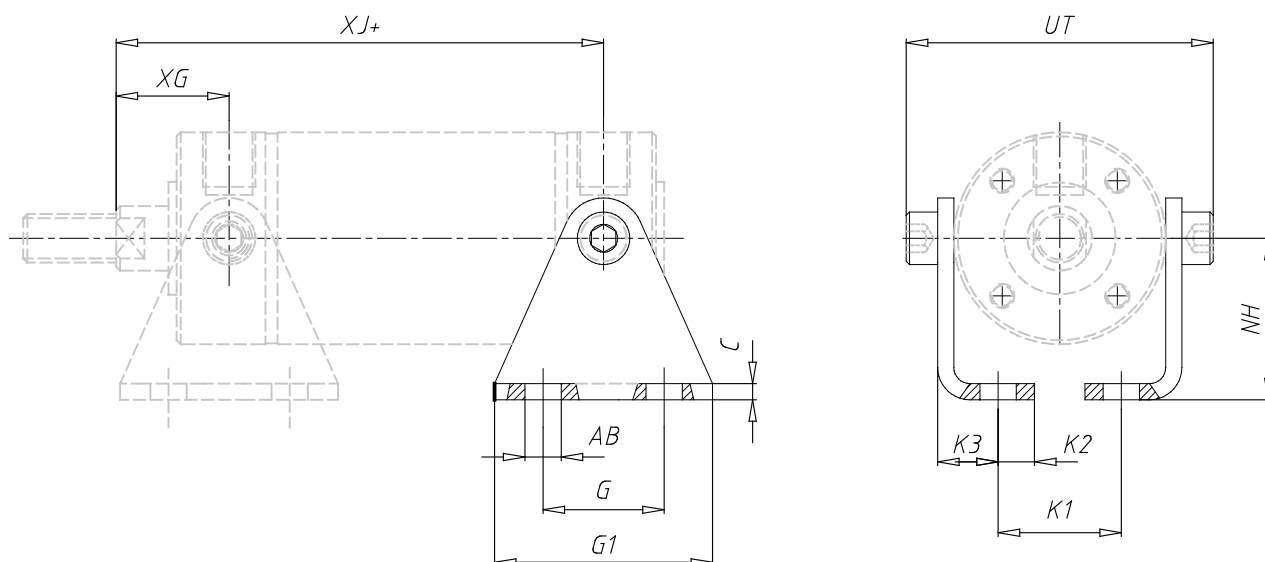

DIMENSIONS

G (mm)	30
G1 (mm)	54
C (mm)	4
XJ (mm)	84
XG (mm)	26
Ø AB (mm)	9
K1 (mm)	30.5
K2 (mm)	9
K3 (mm)	15.0
NH (mm)	40
UT (mm)	68