

Rear Trunnion bracket - Mod. I

Product code: I-12-16

Datasheet creation date: 19/05/2026 09:06

Check the most updated document online [click here](#)



TECHNICAL DATA

Mod.	I-12-16
------	---------

Rear Trunnion bracket - Mod. I

Product code: I-12-16

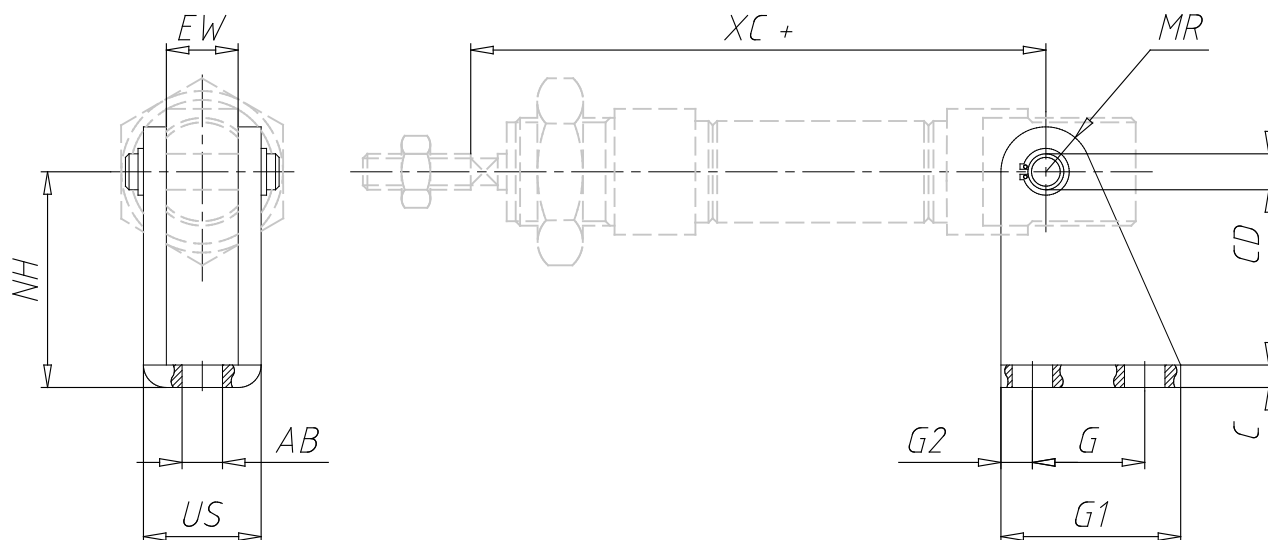

DIMENSIONS

G1 (mm)	25
G (mm)	15.0
G2 (mm)	5.0
CD (mm)	6
AB (mm)	5.5
C (mm)	3.0
NH (mm)	27
EW (mm)	12
US (mm)	18.1
MR (mm)	7.0
XC (mm)	75 - 82