

Piston Rod Socket Joint - Mod. GY

Product code: GY-32

Datasheet creation date: 19/05/2026 09:04

Check the most updated document online [click here](#)



TECHNICAL DATA

Mod.	GY-32
------	-------

Piston Rod Socket Joint - Mod. GY

Product code: GY-32

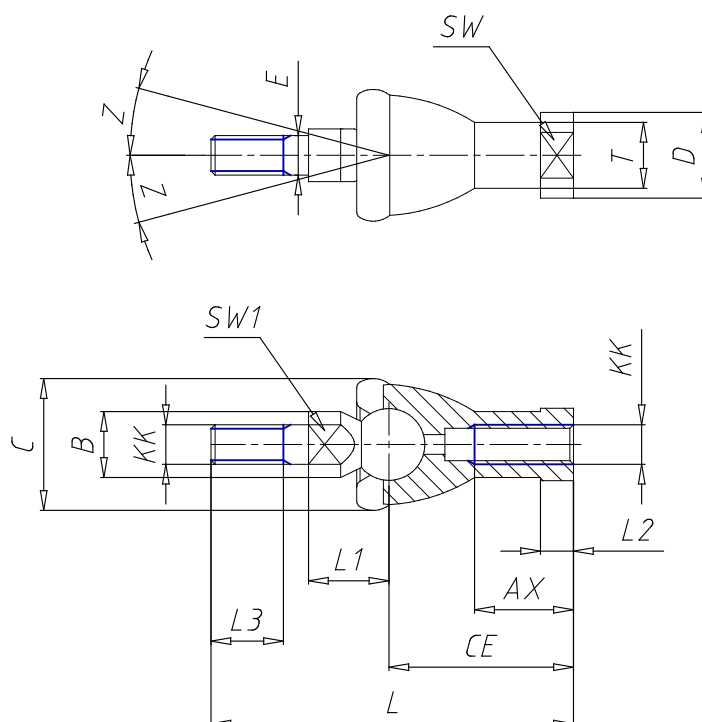

DIMENSIONS

KK	M 10x1.25
L (mm)	74
CE (mm)	35
L2 (mm)	6.5
AX (mm)	18
E (mm)	10
Ø B (mm)	14
Ø C (mm)	28
Ø T (mm)	15.0
Ø D (mm)	19
L1 (mm)	19.5
L3 (mm)	15
SW1 (mm)	11
SW (mm)	17
Z (mm)	15