

Valves - Series GSCU

Product code: GSCU 805-1/4-8

Datasheet creation date: 19/05/2026 08:50

Check the most updated document online [click here](#)



TECHNICAL DATA

Mod.	GSCU 805-1/4-8
------	----------------

Valves - Series GSCU

Product code: GSCU 805-1/4-8

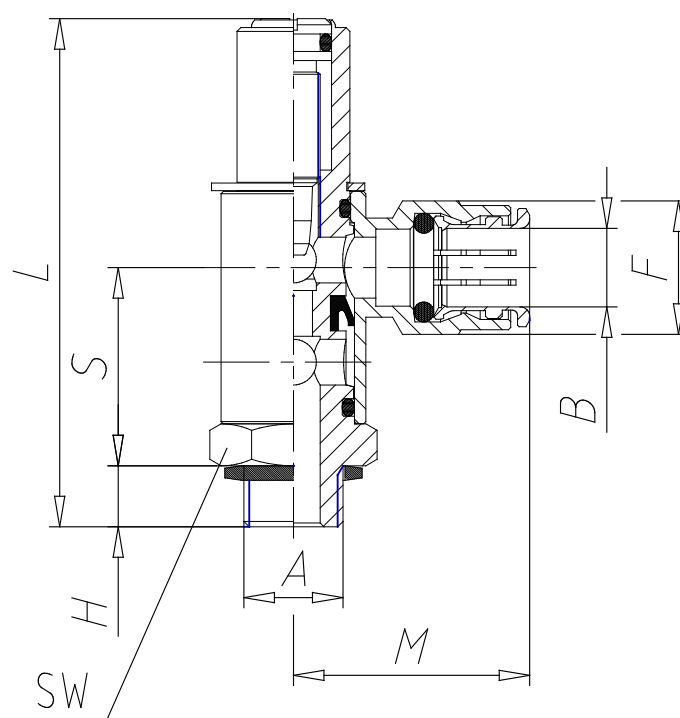

DIMENSIONS

A	G1/4
B (mm)	8
S (mm)	27.0
H (mm)	7
L (mm)	67.5
M (mm)	28.5
F (mm)	15.0
SW (mm)	19