

Self compensating adaptor - Mod. GKF

Product code: GKF-25-32

Datasheet creation date: 19/05/2026 09:10

Check the most updated document online [click here](#)



TECHNICAL DATA

Mod.	GKF-25-32
------	-----------

Self compensating adaptor - Mod. GKF

Product code: GKF-25-32

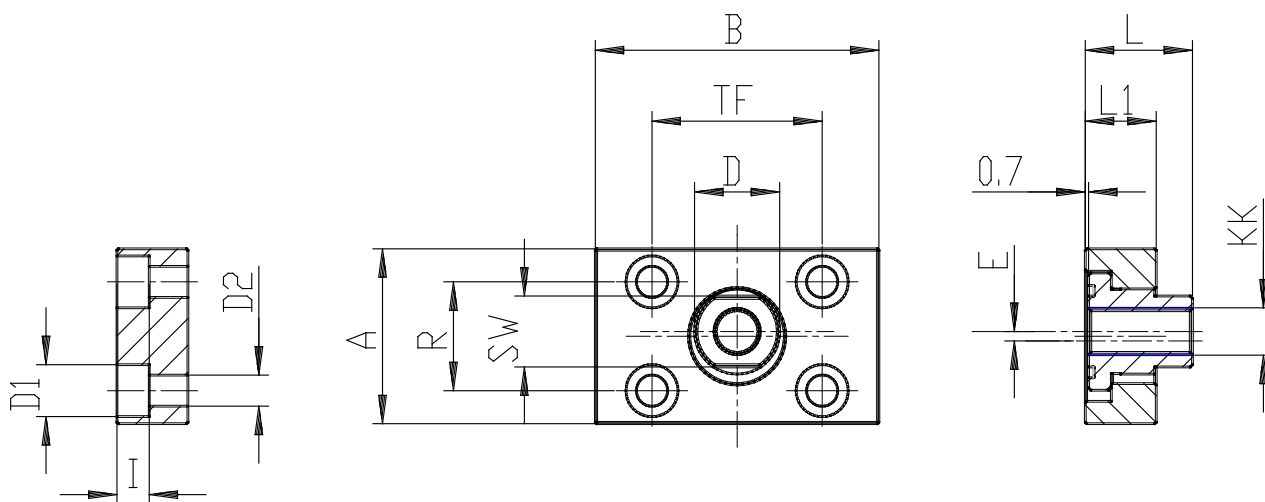

DIMENSIONS

KK	M10X1,25
A (mm)	37
B (mm)	60
R (mm)	23
TF (mm)	36
L (mm)	22.5
L1 (mm)	15
I (mm)	6.8
D (mm)	18.0
D1 (mm)	11.0
D2 (mm)	6.6
SW (mm)	15
E (mm)	2.0