

## Rod Fork - Mod. G

Product code: G-20

Datasheet creation date: 19/05/2026 09:04

Check the most updated document online [click here](#)



### TECHNICAL DATA

Mod.	G-20
------	------

## Rod Fork - Mod. G

Product code: G-20

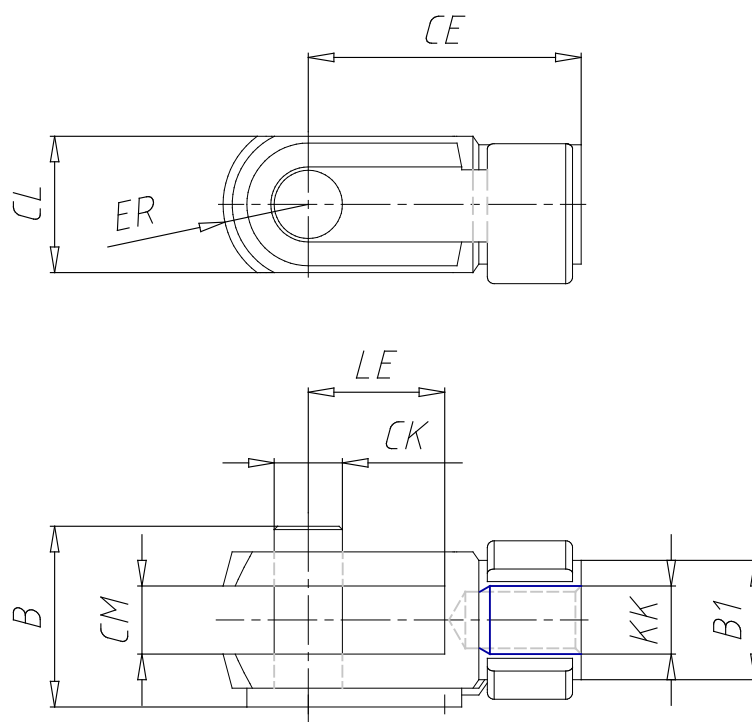

### DIMENSIONS

Ø CK (mm)	8
LE (mm)	16
CM (mm)	8
CL (mm)	16
ER (mm)	10
CE (mm)	32
KK	M 8x1.25
B (mm)	22
Ø B1 (mm)	14