

Centre trunnion - Mod. F-41

Product code: F-41-160

Datasheet creation date: 19/05/2026 08:31

Check the most updated document online [click here](#)



■ TECHNICAL DATA

Mod.	F-41-160
------	----------

Centre trunnion - Mod. F-41

Product code: F-41-160

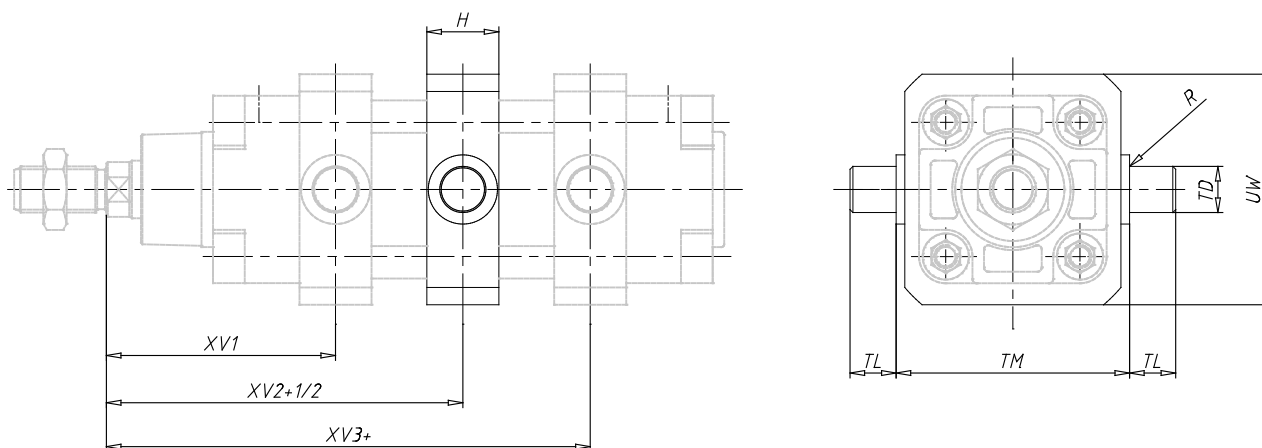

DIMENSIONS

XV1 (mm)	145
XV2 (mm)	170
XV3 (mm)	195
TM (mm)	200
TK (mm)	40
TD (mm)	32
TL (mm)	32
UW (mm)	190
R (mm)	0.2