

Blanking plate for manifolds - Series 4

Product code: CNVL/3

Datasheet creation date: 20/05/2026 01:54

Check the most updated document online [click here](#)



TECHNICAL DATA

Mod.	CNVL/3
------	--------

Blanking plate for manifolds - Series 4

Product code: CNVL/3

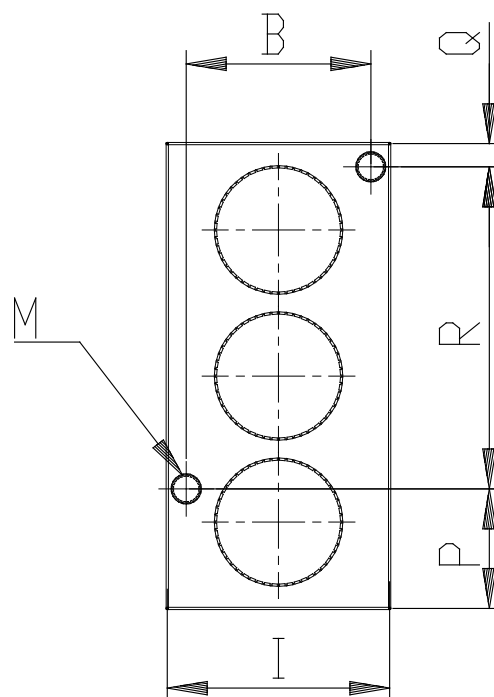
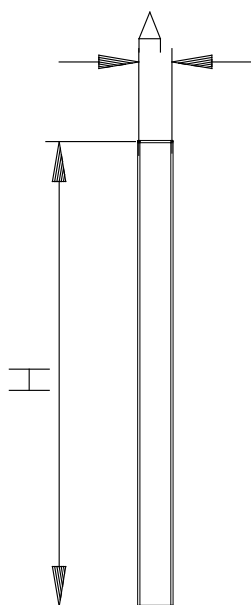

DIMENSIONS

SD	Series 4, size 1/4"
A (mm)	5
B (mm)	27.8
H (mm)	70
I (mm)	33.5
M (mm)	4.2
P (mm)	7.5
Q (mm)	3.5
R (mm)	48.5