

Micro pressure regulators - Series CLR

Product code: CLR 1/8-8

Datasheet creation date: 19/05/2026 09:00

Check the most updated document online [click here](#)



TECHNICAL DATA

Mod.	CLR 1/8-8
------	-----------

Micro pressure regulators - Series CLR

Product code: CLR 1/8-8

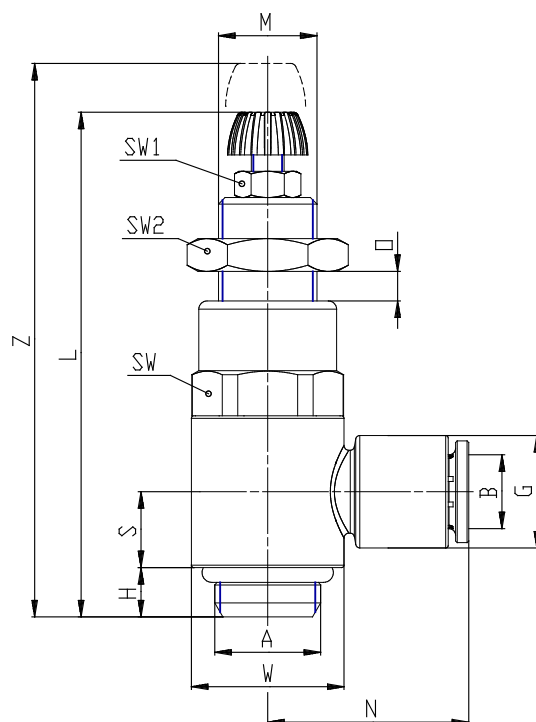

DIMENSIONS

Mod.	CLR 1/8-8
------	-----------