

Micro pressure regulators - Series CLR

Product code: CLR 1/8-4

Datasheet creation date: 19/05/2026 08:51

Check the most updated document online [click here](#)



TECHNICAL DATA

Mod.	CLR 1/8-4
------	-----------

Micro pressure regulators - Series CLR

Product code: CLR 1/8-4

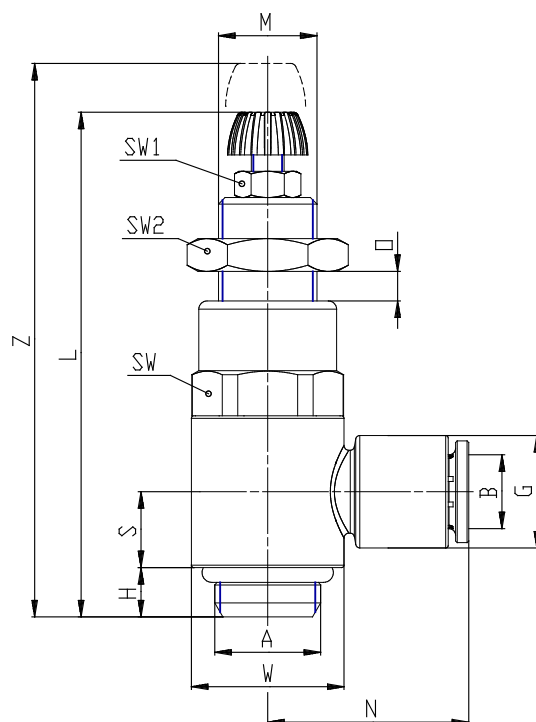

DIMENSIONS

Mod.	CLR 1/8-4
------	-----------