

## Micro pressure regulators - Series CLR

Product code: CLR 1/4-6

Datasheet creation date: 19/05/2026 08:51

Check the most updated document online [click here](#)



### TECHNICAL DATA

Mod.	CLR 1/4-6
------	-----------

## Micro pressure regulators - Series CLR

Product code: CLR 1/4-6

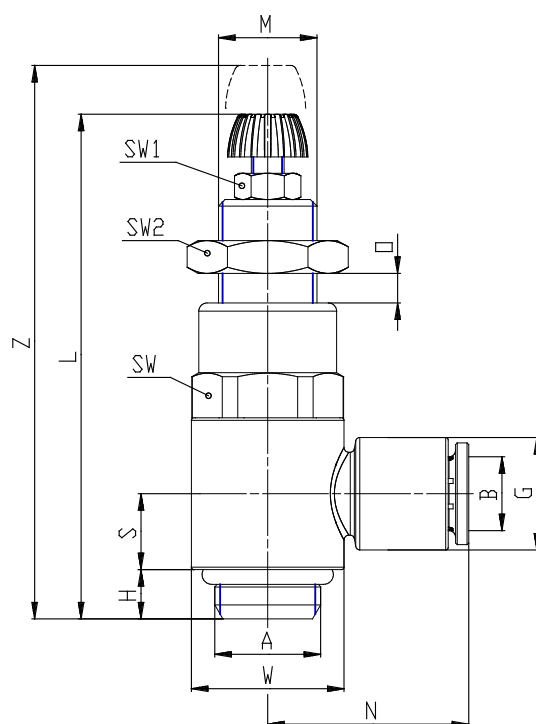

### DIMENSIONS

Mod.	CLR 1/4-6
------	-----------