

Foot mount - Mod. B

Product code: B-8-10

Datasheet creation date: 19/05/2026 09:06

Check the most updated document online [click here](#)



■ TECHNICAL DATA

Model	B-8-10
-------	--------

Foot mount - Mod. B

Product code: B-8-10

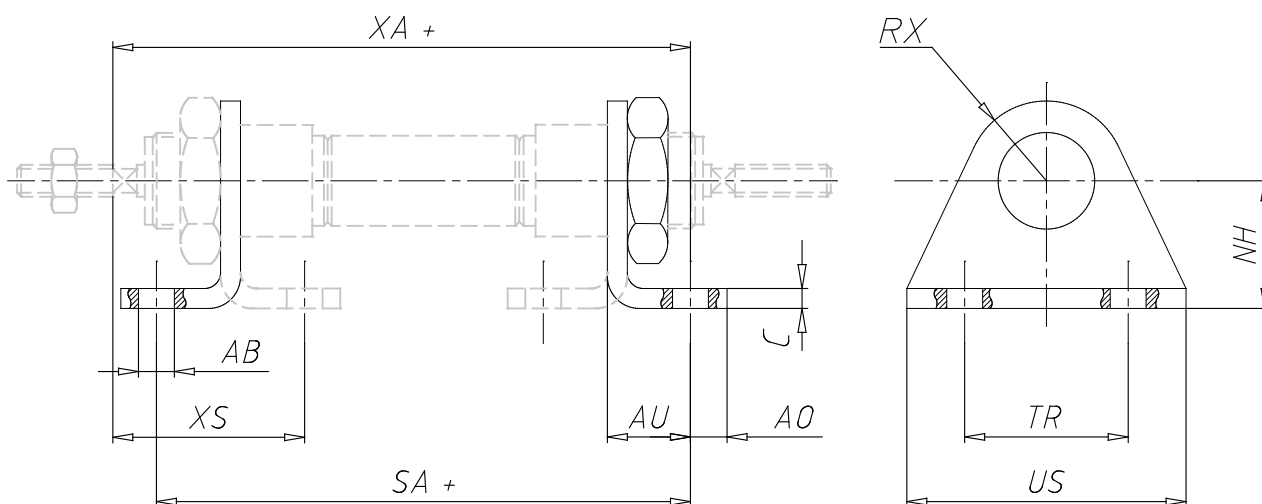

DIMENSIONS

TR (mm)	25
US (mm)	35
AB (mm)	4.5
C (mm)	2.5
NH (mm)	16
AO (mm)	4.5
AU (mm)	10.5
NH (mm)	10
XA (mm)	72.5
XS (mm)	24
R (mm)	6.05