

Foot mount - Mod. B

Product code: B-12-16

Datasheet creation date: 19/05/2026 08:54

Check the most updated document online [click here](#)



■ TECHNICAL DATA

Model	B-12-16
-------	---------

Foot mount - Mod. B

Product code: B-12-16

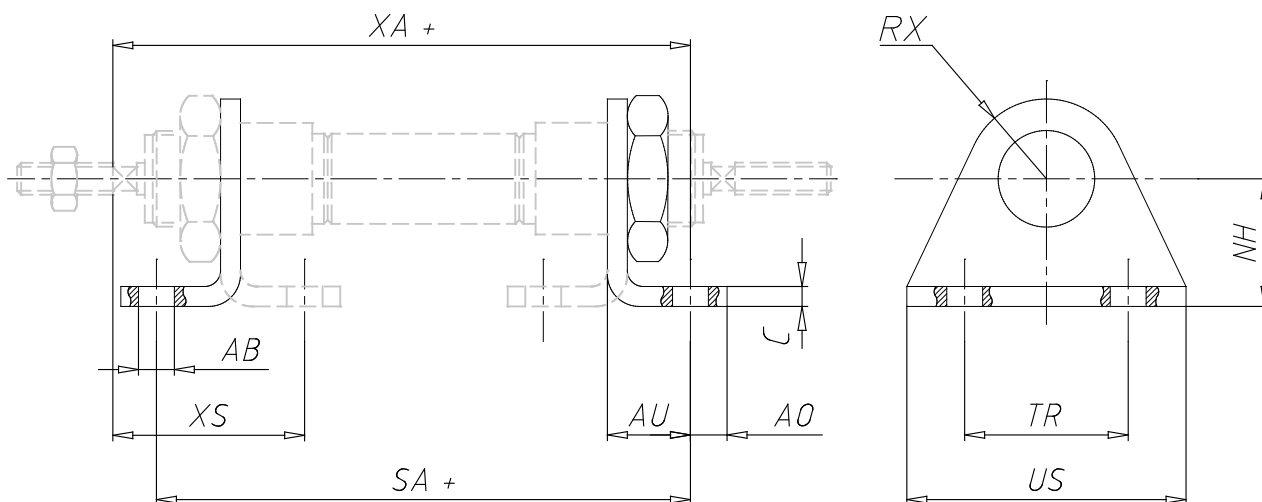

DIMENSIONS

TR (mm)	32
US (mm)	42
AB (mm)	5.5
C (mm)	3.0
NH (mm)	20
AO (mm)	6.0
AU (mm)	13.0
NH (mm)	13
XA (mm)	82.5
XS (mm)	32
R (mm)	8.05