

Solenoids for solenoid valves - Mod. A80

Product code: A8E

Datasheet creation date: 19/05/2026 08:46

Check the most updated document online [click here](#)



TECHNICAL DATA

Mod.	A8E
Voltage (V)	220
Frequency (Hz)	50 / 60
Power absorption	5 VA

Solenoids for solenoid valves - Mod. A80

Product code: A8E

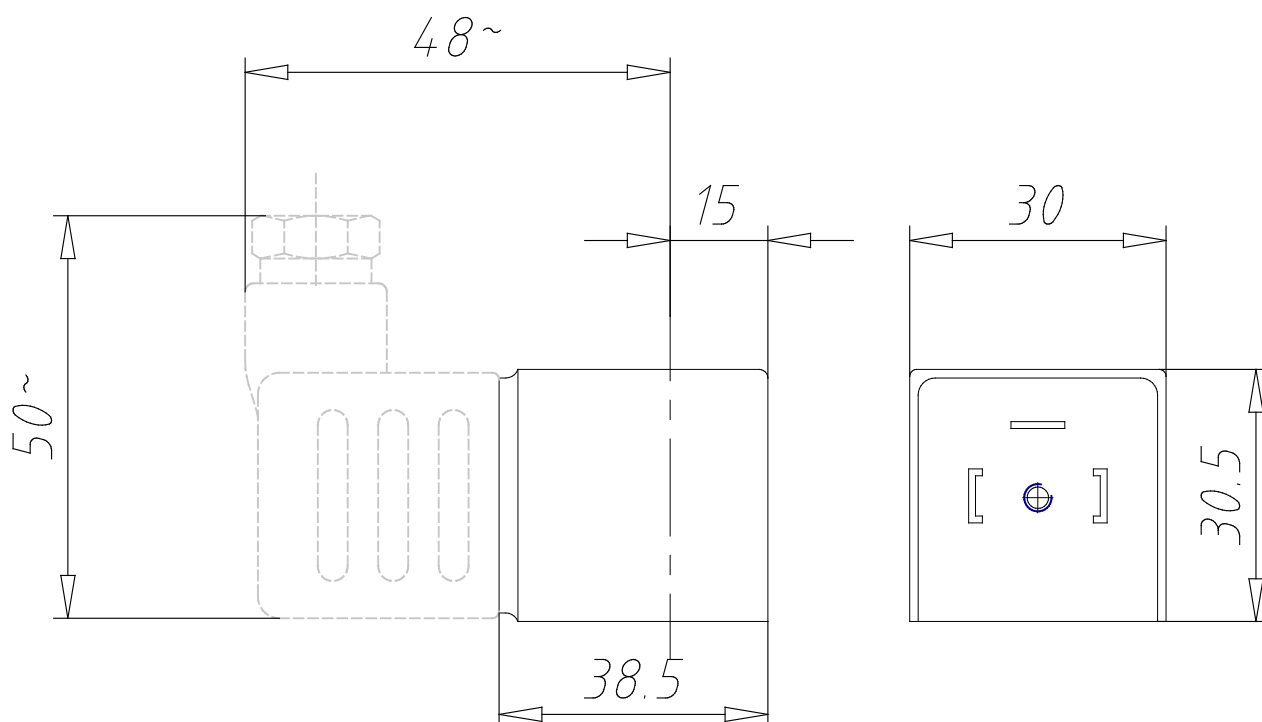

DIMENSIONS

Mod.	A8E
Voltage (V)	220
Frequency (Hz)	50 / 60
Power absorption	5 VA